

# Catalog

Ersa soldering irons, soldering and desoldering stations, solder fume extractions, hybrid rework equipment and accessories



**Dystrybutor:**

Elblinger Elektronik Sp. z o.o.  
ul. Kwiatowa 25  
60-185 Skórzewo k. Poznań

Telefon: 061 / 894 69 90  
Fax: 061 / 894 69 99

E-mail: [mail@elblinger-elektronik.pl](mailto:mail@elblinger-elektronik.pl)  
Internet: [www.elblinger-elektronik.pl](http://www.elblinger-elektronik.pl)



 **kurtz ersa**

## Quickfinder – the alpha-numerical product index

Order no.	page	Order no.	page	Order no.	page
<b>00</b>		<b>09</b>		OICV2000AI.....	21
0003B-0008M.....	33	0910BD, 0920BD, 0930CD.....	6	OICV2000AXV.....	21
0012... tip.....	45	0960ED.....	8	OICV2000HP.....	21
0015BDH.....	6	<b>0A</b>		OICV403A.....	21
0032... tips.....	45	0A04 – 0A57.....	33	OICV4000A.....	21
0042... tips.....	45	0A08MSET.....	33	OICV4000AI.....	21
0045BDG.....	6	0ANA60.....	13	OICV4000AIC.....	21
0052... tips.....	45	0ANA60A.....	13	OICV4000AICXV.....	21
0055JD.....	7	0AS196.....	31	OIRHP100A-03.....	30
0085JD.....	7	<b>0C</b>		OIRHP200.....	30
0082... tips.....	45	0CA...(CLEAN-AIR).....	28	OIRHR100A, OIRHR100A-HP.....	24
<b>01</b>		0CU103A.....	18/19	OIRHR100A-14/-15/-16/-24.....	24
0100CDJ.....	18/19/21	<b>0D</b>		OIRHR-ST050.....	24
0102... tips.....	38/39	0DIG20A27.....	22	<b>0L</b>	
0120CDK.....	17	0DIG20A45.....	22	0LS197.....	31
0130CDK.....	17	0DIG20A64.....	22	<b>0P</b>	
0132... tips.....	44	0DIG20A84.....	22	0PR100.....	25
0152... tips.....	45	0DTM100.....	31	0PR100-PL550.....	25
0155JD.....	7	0DTM100P.....	31	0PR100-PL650.....	25
0162... tips.....	44	<b>0E</b>		0PR100-D001/-D002/-D003.....	25
0172... tips.....	44	0E015CD, 0E025CD, 0E035VD.....	5	<b>0R</b>	
0185PZ.....	30	<b>0F</b>		0RA4500D.....	11/30
0182PZ004.....	30	0F007, 0F008.....	11	0RDS80.....	13
<b>02</b>		0FMIF2005-002.....	35	<b>0S</b>	
0200MZ/MD.....	7	0FMIF6000-001.....	35	0SH03.....	23/33
0202MZ/MD.....	45	0FMIF8001-001.....	35	0SMD8012.....	23
0212... tips.....	42	0FMKANC32-005.....	35	0SMD8013.....	23
0240CDJ.....	21	0FMKANC32-200.....	35	0SMD8014.....	23
0242... tips.....	41	0FMPEN.....	35	0SR100, 0SR101.....	32
0260BD.....	6	0FR202, 0FR203, 0FR400.....	35	0STR100, 0STR200.....	32
0270BDJ.....	22	<b>0G</b>		0SVP100.....	31
<b>03</b>		0G072... tips.....	44	0SVP12K, 0SVP13A.....	31
0300MZ/MD.....	7	0G07400041, 0G07400141.....	9	<b>0T</b>	
0302MZ/0302MD.....	45	0G132... tips.....	44	0T02-0T56.....	11
0330KD, 0330KD0028, 0340KD ..	6	0G13400041, 0G13400141.....	9	0TR01/SB, 0TR02/SB.....	35
<b>04</b>		0G156.....	33	<b>0V</b>	
0422... tips.....	43	<b>0H</b>		0VACX/2.....	31
0450MDJ.....	22	0HR200.....	24	0VPO20.....	24
0452... tips.....	43	0HR200-HP.....	24	<b>0W</b>	
0460MDJ.....	18/19/21	<b>0I</b>		0WICKNC desoldering wicks.....	35
0462... tips.....	42	0IC128.....	17	<b>2</b>	
0470BRJ.....	21	0IC1100A.....	18	291405, 290763.....	28
0472... hot-air nozzles.....	43	0IC1100AOC.....	18	<b>3C</b>	
<b>05</b>		0IC1100V.....	18	3CA...(CLEAN-AIR).....	28
0550MZ/MD.....	7	0IC1100VCV.....	18	<b>3I</b>	
0552MZ/MD.....	45	0IC1100VXT.....	18	3IRHR100A-01.....	24
<b>06</b>		0IC1100VOC.....	18	<b>3N</b>	
0612... tips.....	41	0IC1200A.....	17	3N194.....	33
0640ADJ.....	23	0IC1300.....	17	<b>3Z</b>	
0670CDJ, 0680CDJ.....	13	0IC2200V.....	19	3ZT00164.....	32
<b>07</b>		0IC2200VC.....	19	3ZT00051.....	37
0710CD.....	8	0IC2200VIT.....	19	<b>4F</b>	
0722er/0742... tips.....	46	0IC2200VXT.....	19	4FMJF6000-, 4FMJF8001-PEN.....	35
0740EDJ.....	18/19/21	0IC2200VOC.....	19	4FMJF8300-005, -030.....	35
0760CD.....	8	OICV203A.....	21	<b>4L</b>	
<b>08</b>		OICV203AP.....	21	4LOT230G64B.....	34
0832... tips.....	40	OICV203HP.....	21	4LOT230GAG3.5CU0.7.....	34
0840CDJ.....	22	OICV207.....	21	E074600.....	37
0842er, 0852... tips.....	40	OICV2000A.....	21	E074700.....	37
0890CDJ.....	13	OICV2000AC.....	21		

PTC

Identifies devices, that work or can work with ceramic heating elements with positive temperature coefficient (PTC)

# Contents

## Soldering irons and sets

<b>Universal soldering irons</b>	
ERSA 15+/25+/35+ .....	5
<b>Miniature soldering irons</b>	
MINOR S, MINITYP S .....	6
<b>Micro/universal soldering iron</b>	
MULTITIP SERIES, TIP 260 .....	6
MULTI-PRO, ERSA 30 S .....	6
<b>Standard soldering irons</b>	
ERSA 50 S/80 S/150 S .....	7
<b>Workshop soldering irons</b>	
ERSA 200 – ERSA 550 .....	7
<b>High-speed soldering irons</b>	
MULTI-SPRINT, PTC 70, MULTI-TC .....	8
<b>Gas soldering irons</b>	
INDEPENDENT 75/130 .....	9

## Solder baths

Mini solder bath, static solder baths .....	11
RA 4500 D temperature regulator .....	11
Temperature sensor .....	11

## Soldering stations

<b>Soldering stations</b>	
RDS 80 .....	13
ANALOG 60/ANALOG 60 A .....	14
DIGITAL 2000 A .....	22

## i-CON soldering/desoldering stations

<b>Multifunctional soldering/ desoldering stations</b>	
i-CON1 C/2 C .....	15-16
i-CON PICO/ i-CON NANO .....	17
i-CON1/i-CON1 V .....	18
i-CON2 V .....	19
i-CON VARIO 2 .....	20
i-CON VARIO 4 .....	21
DIGITAL 2000 A .....	22
Tip holder .....	23
<b>Hybrid rework system</b>	
HR 100 .....	24
HR 200 .....	24
<b>Solder paste printing</b>	
DIP & PRINT-STATION .....	25

## „CLEAN-AIR“ – solder fume extractions

<b>Extractions for the workbench</b>	
Ersa EASY ARM 1 + 2 .....	27/28

## Accessories and process materials

<b>Accessories</b>	
IRHP 200/IRHP 100 A heating plates .....	30
Plastics welding device 185 PZ .....	30
DTM temperature measuring device .....	31
Vacuum pipette .....	31
Desoldering tools .....	31
Stacking rack .....	32
Solder wire dispenser .....	32
Multifunctional tip exchanger .....	32
HOLDERS and sponges .....	33
<b>Process materials</b>	
Solder wires, solder bars .....	34
Fluxes, desoldering wicks .....	35
Desoldering wicks .....	35
FLUX PEN, FLUX REMOVER AND TIP REACTIVATOR .....	35

## Soldering and desoldering tips

### Soldering and desoldering tips

102 series .....	38/39
832, 842, 852 series .....	40
612, 242 series .....	41
212, 462 series .....	42
422, 452, 472 series .....	43
172, 162, 132, G 072, G 132 series .....	44
042, 012, 032, 052, 082, 152, 202, 302, 552 series .....	45
722, 742 series .....	46
ERSADUR tip structure .....	37
Professional care of soldering tips .....	37

## References

Ersa inspection systems .....	47
Ersa rework systems .....	48
Ersa training/training programs .....	49
Ersa soldering systems .....	50
Sustainability .....	51

# Soldering irons and sets

The success story of Ersa soldering irons started in 1921 when the company's founder Ernst Sachs applied for patent for the first electric soldering iron.

Today, the soldering irons and sets, high-speed soldering irons and gas powered soldering irons have proven their merit many times over throughout the world, always providing the fitting solution for various applications.

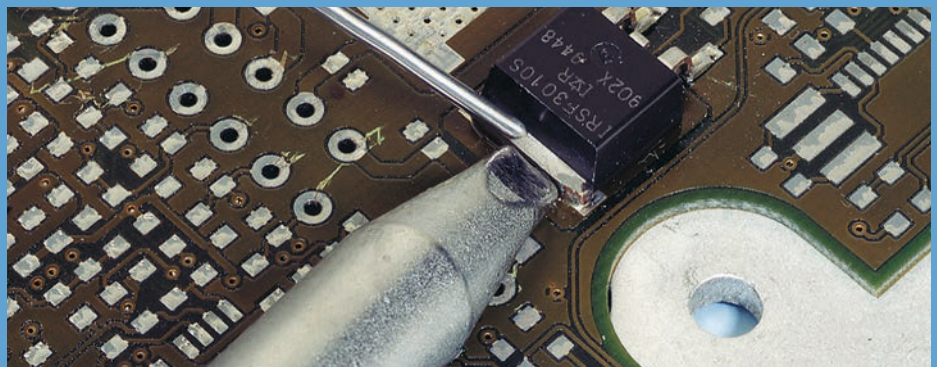

# Ersa universal soldering irons



The **ERSA 15+** and **25+** universal soldering irons are the perfect tools for cost-conscious soldering. Internally heated tips provide a high level of efficiency. The varied range of thin soldering tips of the 832 and 842 series can be used. The safe performance of fine soldering applications is supported by the ergonomic design of the handle.

The **ERSA 35+** universal soldering iron is most suitable for applications with high heat requirements. Internally heated tips of the 852 series guarantee best heat transfer at a high level of efficiency. The ergonomic handle provides secure tool handling for all soldering applications.



## ERSA 15+

Soldering tip series 832 and 842 see page 40



## ERSA 25+

Soldering tip series 832 and 842 see page 40



## ERSA 35+

Soldering tip series 852 see page 40

Order no.	Description	With soldering tip	Rating/voltage	Heating time	Max. tip temperature	Weight (w/o cable)
0E015CD <b>1E015CDA068</b>	ERSA 15+ soldering iron	0832CD, ERSADUR	15 W/230 V <b>15 W/115 V</b>	approx. 120 s	approx. 400 °C	50 g
0E025CD <b>1E025CDA068</b>	ERSA 25+ soldering iron	0842CD, ERSADUR	25 W/230 V <b>25 W/115 V</b>	approx. 120 s	approx. 450 °C	50 g
0E035VD <b>1E035VDA068</b>	ERSA 35+ soldering iron	0852VD, ERSADUR	35 W/230 V <b>35 W/115 V</b>	approx. 120 s	approx. 450 °C	50 g

## Internally heated soldering tips for best energy efficiency



**Up to 20% higher level of efficiency due to internally heated soldering tips.**

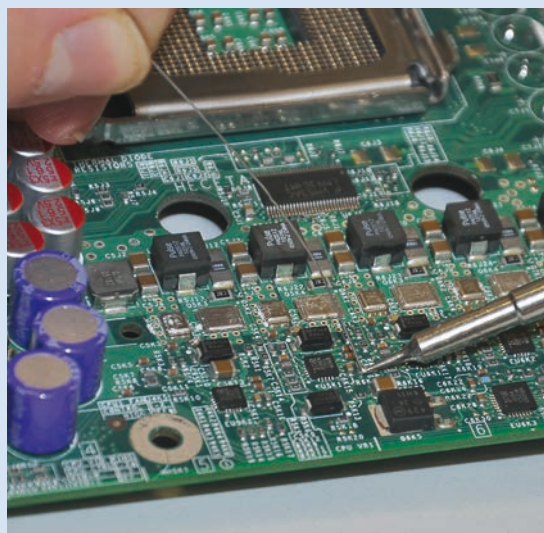

The soldering tip is the "heart" of the soldering iron and responsible for the heat transfer from the heating element via solder to the solder joint.

Depending on the soldering iron and application, different types of tips are available. Prerequisites for good solder joints are the correct soldering iron tip shape, perfect heat transfer, a good condition of the tip and reliable stability.

For an optimal heat transfer from the heating element to the soldering tip, internally heated soldering tips are definitely superior to externally heated

soldering tips. This difference in technology raises the level of efficiency of the whole soldering iron by up to 20%.

This is why a higher level of performance can be reached with the same input of energy. This advantage is implemented consequently at all new universal soldering irons Ersa 15+, Ersa 25+ as well as Ersa 35+.

Good success for your soldering job!

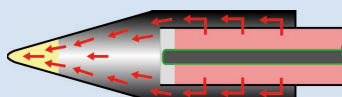

*The internal heating element ensures most efficient heating transfer and therefore high efficiency on the top of the tip.*

## Ersa miniature soldering irons



The **MINOR S (5 W)** and **MINITYP S (6 W)** miniature soldering irons with ERSADUR tips are suitable for the finest-detailed soldering work on micro-circuits.

The MINOR S can be operated with a 6 V transformer or a 6 V battery. Besides electronics, the MINOR S is also used in watch repair, in the photographic industry and in dental technology.

The MINITYP S can be operated with a 12 V battery.



### MINOR S

Soldering tip series 042 see page 45

### MINITYP S

Soldering tip 012 see page 45

Order no.	Description	With soldering tip	Rating/voltage	Heating time	Max. tip temperature	Weight (w/o cable)
0045BDG	MINOR S soldering iron	0042BD, ERSADUR	5 W/6 V	12 s	approx. 440 °C	6 g
0015BDH	MINITYP S soldering iron	0012BD, ERSADUR	6 W/12 V	20 s	approx. 390 °C	7 g

## Ersa micro/universal soldering irons



PTC

The Ersa **MULTITIP** series covers a wide range of applications. It stands out by its low weight and compact design (short distance between soldering tip and the handle's front part). The handle stays relatively cool while soldering.

The MULTITIP is available for **15 W** and **25 W** and suitable for both micro-soldering joints and medium-sized soldering, as on distributor strips. Long-life and industrially tested PTC heating elements and internally heated soldering tips provide high efficiency and fast heat supply.

The **TIP 260** is also heated in this especially efficient way. **16 W** power and slim design make this soldering iron an ideal aid when working on electronic assemblies in places difficult to access.



### MULTITIP C15

Soldering tip series 162 see page 44



### MULTITIP C25

Soldering tip series 172 see page 44



### TIP 260

Soldering tip series 162 see page 44

Order no.	Description	With soldering tip	Rating/voltage	Heating time	Max. tip temperature	Weight (w/o cable)
0910BD	MULTITIP C15 soldering iron	0162BD, ERSADUR	15 W/230 V	approx. 120 s	approx. 350 °C	28 g
<b>1910BDA068</b>			<b>15 W/115 V</b>			
0920BD	MULTITIP C25 soldering iron	0172BD, ERSADUR	25 W/230 V	approx. 90 s	approx. 450 °C	34 g
<b>1920BDA068</b>			<b>25 W/115 V</b>			
0260BD	TIP 260 soldering iron	0162BD, ERSADUR	16 W/230 V	approx. 120 s	approx. 350 °C	40 g
<b>1260BDA068</b>			<b>16 W/115 V</b>			

## Ersa universal soldering irons



Wide range of soldering tips!

Thanks to its large range of tips, the Ersa **MULTI-PRO** is the ideal soldering iron when great flexibility is required. It has a heat-resistant connecting cable. Internally heated tips provide a high level of efficiency.

**ERSA 30 S**, the best selling and most tried and tested universal soldering iron, is known the world over for its sturdiness and longevity. It can be used in a variety of ways for soldering tasks in handicrafts, service and hobbies. Delivery includes a practical, easy to mount rubber stick-on support disk. The ERSA 30 S is available with **30 W** and **40 W**.



### MULTI-PRO

Soldering tip series 832/842 see page 40

30 W

40 W



### ERSA 30 S\*

Soldering tip series 032 see page 45

\*also available with heat-resistant cable, order no. 0330KD0028

Order no.	Description	With soldering tip	Rating/voltage	Heating time	Max. tip temperature	Weight (w/o cable)
0930CD	MULTI-PRO soldering iron	0832CDLF, ERSADUR	20 W/230 V	approx. 5 min	approx. 430 °C	60 g
<b>1930CDA068</b>			<b>20 W/115 V</b>			
0330 KD	ERSA 30 S soldering iron	0032KD, ERSADUR	30 W/230 V	approx. 2 min	approx. 380 °C	80 g
<b>1330KDA068</b>			<b>30 W/115 V</b>			
0340 KD	ERSA 30 S soldering iron	0032KD, ERSADUR	40 W/230 V	approx. 2 min	approx. 420 °C	80 g
<b>1340KDA068</b>			<b>40 W/115 V</b>			

## Ersa standard soldering irons



The tried and proven soldering irons of the **ERSA 50 S / 80 S / 150 S** series are designed for soldering operations with a greater heat requirement, as, for example, on copper conductors with a cross-section of 2.5 mm<sup>2</sup> (ERSA 50 S, 50 W) to 6 mm<sup>2</sup> (ERSA 150 S, 150 W).

The devices are supplied with an angled soldering tip as standard. Thanks to their elaborately generated "protective coating", ERSADUR tips have a much longer service life than their simple mates.

Other areas of application of the Ersa standard soldering irons include soldering thin sheet metal and lead glazing (ERSA 150 S).



### ERSA 50 S

Soldering tip series 052 see page 45



### ERSA 80 S

Soldering tip series 082 see page 45



### ERSA 150 S

Soldering tip series 152 see page 45

Order no.	Description	With soldering tip	Rating/voltage	Heating time	Max. tip temperature	Weight (w/o cable)
0055JD <b>1055JDA068</b>	ERSA 50 S soldering iron	0052JD, ERSADUR	50 W/230 V <b>50 W/115 V</b>	approx. 3 min	approx. 400 °C	160 g
0085JD <b>1085JDA068</b>	ERSA 80 S soldering iron	0082JD, ERSADUR	80 W/230 V <b>80 W/115 V</b>	approx. 3 min	approx. 410 °C	220 g
0155JD <b>1155JDA068</b>	ERSA 150 S soldering iron	0152JD, ERSADUR	150 W/230 V <b>150 W/115 V</b>	approx. 3 min	approx. 450 °C	245 g

## Ersa workshop soldering irons



The **ERSA 200, 300** and **550** hammer soldering iron series are especially suitable for sheet metal processing, installation work and for soldering commutators and copper bus bars.

Hammer soldering irons have also proven their merit in automotive body adjustments and lead glazing.

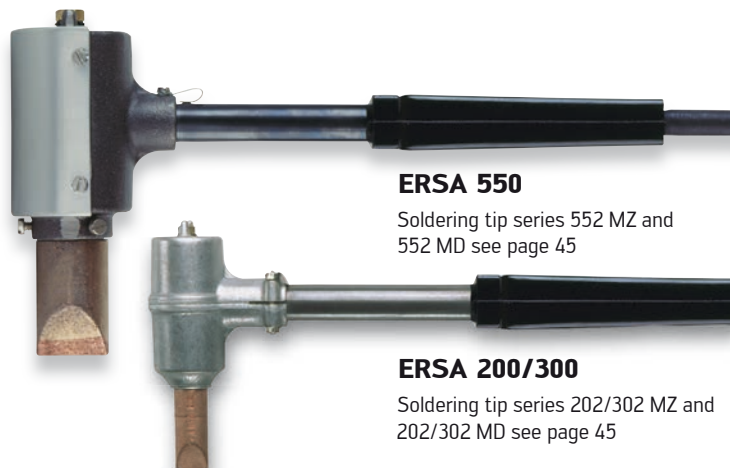

### ERSA 550

Soldering tip series 552 MZ and 552 MD see page 45

### ERSA 200/300

Soldering tip series 202/302 MZ and 202/302 MD see page 45

Order no.	Description	With soldering tip	Rating/voltage	Heating time	Max. tip temperature	Weight (w/o cable)
0200MZ <b>1200MZA068</b>	ERSA 200 hammer soldering iron	0202MZ, nickel-plated	200 W/230 V <b>200 W/115 V</b>	approx. 5 min	approx. 470 °C	550 g
0200MD <b>1200MDA068</b>	ERSA 200 hammer soldering iron	0202MD, ERSADUR	200 W/230 V <b>200 W/115 V</b>	approx. 5 min	approx. 470 °C	550 g
0300MZ <b>1300MZA068</b>	ERSA 300 hammer soldering iron	0302MZ, nickel-plated	300 W/230 V <b>300 W/115 V</b>	approx. 5 min	approx. 470 °C	870 g
0300MD <b>1300MDA068</b>	ERSA 300 hammer soldering iron	0302MD, ERSADUR	300 W/230 V <b>300 W/115 V</b>	approx. 5 min	approx. 470 °C	870 g
0550MZ <b>1550MZA068</b>	ERSA 550 hammer soldering iron	0552MZ, nickel-plated	550 W/230 V <b>550 W/115 V</b>	approx. 7 min	approx. 600 °C	1,770 g
0550MD <b>1550MDA068</b>	ERSA 550 hammer soldering iron	0552MD, ERSADUR	550 W/230 V <b>550 W/115 V</b>	approx. 7 min	approx. 600 °C	1,770 g

## Ersa high-speed soldering irons

The Ersa **MULTI-SPRINT** is an extremely light, transformer-independent solder gun with a heat-up rating of up to **150 W** and an ergonomic design.

In combination with the internally heated ERSADUR long-life soldering tip, the MULTI-SPRINT's PTC heating element offers especially high performance. The short heat-up time makes it ideal for high-speed series soldering. The MULTI-SPRINT is heated only as long as the button is pressed.

The large selection of tips of the 832 / 842 series affords a wide range of applications, and not just in service and repairs.



Wide range of soldering tips!

PTC

### MULTI-SPRINT

Soldering tip series 832/842 see page 40



Order no.	Description	With soldering tip	Rating/voltage	Heating time	Max. tip temperature	Weight (w/o cable)
0960ED	MULTI-SPRINT solder gun	0832EDLF, ERSADUR	150/75 W/ 230 V, 50 – 60 Hz	approx. 15 s	subject to how long the button is pressed	100 g

**1960EDA068** **150/75 W/115 V, 50 – 60 Hz**

## Ersa power soldering iron with temperature control

CE DE EMC PTC

The Ersa **PTC 70** is a powerful and sturdy universal soldering iron with Ersa RESISTRONIC temperature control. This proven temperature control system together with the ceramic PTC heating element provides unusually fast heat-up and heat recovery.

Due to the accurate temperature control and the wide range of ERSADUR long-life tips of the 832 and 842 series, the PTC 70 is a perfect tool for both very small solder joints as well as for applications with medium heat requirements. The PTC 70 is supplied with the soldering tip 0832CDLF.



RESISTRONIC control

Wide range of soldering tips!

### PTC 70

Soldering tip series 832/842 see page 40

Order no.	Description	With soldering tip	Rating/voltage	Heat-up rating/heating time	Temperature range	Weight (w/o cable)
0710CD	PTC 70 soldering iron	0832CDLF, ERSADUR	75 W (350 °C)/ 230 V AC	up to 285 W/ approx. 34 s (280 °C)	250 °C – 450 °C	approx. 60 g

**1710CDA068** **75 W (350 °C)/115 V AC**

## Ersa power soldering iron with temperature control

CE DE EMC PTC

The Ersa **MULTI-TC** is a powerful, sturdy, temperature-controlled universal soldering iron with a precise temperature sensor located directly under the internally heated soldering tip. This temperature sensor registers the actual temperature in the immediate vicinity of the solder joint. The heating system with internal PTC heating element immediately reacts to the heat loss and re-heats extremely fast.

The high heating efficiency and the large selection of soldering tips and inserts serve both filigree applications in electronics and applications with standard soldering irons with a rating of up to 150 W. Examples are classical lead glazing and Tiffany soldering.

By dispensing with a heavy transformer and thanks to its heat-resistant connecting cable, the Ersa MULTI-TC is especially suitable for mobile use in service, maintenance and repairs.



SENSISTRONIC control

Wide range of soldering tips!

### MULTI-TC

Soldering tip series 832/842 see page 40



Order no.	Description	With soldering tip	Rating/voltage	Heating time (to 280 °C)	Temperature range	Weight (w/o cable)
0760CD	MULTI-TC soldering iron	0842CD, ERSADUR	75 W (350 °C) 230 V, 50 – 60 Hz	approx. 34 s	250 °C – 450 °C	60 g

**1760CDA068** **75 W (350 °C), 115 V, 50 – 60 Hz**



## Ersa INDEPENDENT 75 gas soldering sets



Mobile power – wherever you want! Powerful, with comprehensive and top-quality equipment, small, handy and practically packed. The **INDEPENDENT 75 BASIC-SET** and **PROFI-SET** gas soldering sets will meet your every need! The ergonomic, antistatic gas soldering iron with piezo ignition is ideal for service and maintenance work, especially if there is no power supply available! The continuously adjustable output of **15 – 75 W (compared with electrical soldering irons)** allows maximum soldering tip temperatures of up to 580 °C. The INDEPENDENT is powered by filtered butane gas. Operating time per gas filling is about 60 min.

Both sets come with a practical carrying case. Besides the standard "BASIC-SET" equipment, the "PROFI-SET" contains two additional soldering tips, a hot blade for cutting high-resistance foam, a hot-gas nozzle, a deflector for heat-shrinkable sleeves and a flame nozzle for micro-welding.



### INDEPENDENT 75 PROFI-SET

consisting of INDEPENDENT 75 gas soldering iron with soldering tip 0G072KN, soldering tips 0G072CN, 0G072AN and 0G072VN, flame nozzle 0G072BE, hot gas nozzle 0G072HE, hot blade 0G072MN and deflector 0G072RE to shrink heat-shrinkable sleeves, tool holder 0A20, cleaning sponge 0006G and sponge container 0G156, packed in a practical plastic case.

**Soldering tip series G 072,** see page 44

### INDEPENDENT 75 BASIC-SET

consisting of INDEPENDENT 75 gas soldering iron with soldering tips 0G072KN and 0G072CN, holder 0A20, cleaning sponge and sponge container, packed in a practical plastic case.



Order no.	Description	With tip 0G072...	Rating	Heating time	Max. tip temperature	Weight
0G07400041	INDEPENDENT 75 BASIC-SET gas soldering set	...KN; ...CN	15 – 75 W	approx. 46 s (280 °C)	approx. 580 °C	73 g
0G07400141	INDEPENDENT 75 PROFI-SET gas soldering set	...KN; ...CN; ...AN; ...VN; ...BE; ...HE; ...MN; ...RE	15 – 75 W	approx. 46 s (280 °C)	approx. 580 °C	73 g

## Ersa INDEPENDENT 130 gas soldering sets



The "big" gas soldering device from Ersa, the **INDEPENDENT 130**, can be applied wherever demanding soldering tasks have to be performed without a power supply.

Its broad range of continuously variable **25 – 130 W (compared with electrical soldering irons)** and its comprehensive range of soldering tips allow a wide variety of uses in service, installation, maintenance and repair work.

The integrated piezo ignition and powering by filtered butane gas ensure the easiest possible handling and great reliability. The operating time per gas filling is about 120 minutes, with a maximum tip temperature of about 580 °C.

Like its smaller mate, the INDEPENDENT 75, the INDEPENDENT 130 is also available in both set versions, namely as a **BASIC-SET** or **PROFI-SET**.



### INDEPENDENT 130 PROFI-SET

consisting of INDEPENDENT 130 gas soldering iron with soldering tip 0G132KN, soldering tips 0G132CN, 0G132AN and 0G132VN, flame nozzle 0G132BE, hot gas nozzle 0G132HE, hot blade 0G132MN and deflector 0G132RE to shrink heat-shrinkable sleeves, cleaning sponge 0006G and sponge container 0G156, packed in a practical plastic case.

**Soldering tip series G 132,** see page 44

### INDEPENDENT 130 BASIC-SET

consisting of INDEPENDENT 130 gas soldering iron with soldering tips 0G132KN and 0G132CN, cleaning sponge and sponge container, packed in a practical plastic case.



Order no.	Description	With tip 0G132...	Rating	Heating time	Max. tip temperature	Weight
0G13400041	INDEPENDENT 130 BASIC-SET gas soldering set	...KN; ...CN	25 – 130 W	approx. 50 s (280 °C)	approx. 580 °C	121 g
0G13400141	INDEPENDENT 130 PROFI-SET gas soldering set	...KN; ...CN; ...AN; ...VN; ...BE; ...HE; ...MN; ...RE	25 – 130 W	approx. 50 s (280 °C)	approx. 580 °C	121 g

# Solder baths

Ersa does not only provide a wide range of standard soldering irons, it is also the first choice when it comes to static solder baths and fitting temperature regulator.

Apart from a wide range of static solder baths with different solder capacities Ersa also provides a large selection of dynamic solder baths namely wave and selective soldering systems. The photo shows a solder bath with multiwave module of a VERSAFLOW selective soldering system.



# Ersa solder baths



Ersa solder baths are electrically heated melting pots for solders. The high-capacity ceramic heating elements are exchangeable and mounted on the pot. They are thermally insulated from the external sheet metal housing.

The **T 02, T 03, T 04, T 05, T 06** and **T 07** solder baths can be switched to half-power operation. Thanks to the high temperature of approximately 600 °C the T 02 and T 07 baths are especially suitable for tin plating enameled copper wires.

All solder baths are supplied with a 1.5 m connecting cable. To enhance solder quality as well as to reduce oxide formation, and for energy-saving reasons, we recommend the RA 4500 D temperature regulator together with one of the temperature sensors mentioned below.

The **T 50 S / T 10 S** mini solder baths are primarily used for tin-plating stranded wire braids, connecting leads and cable lugs. The heat-resistant special color (order no. 4HMFARBE1) can be applied to the crucible as a protection against corrosion and wetting.

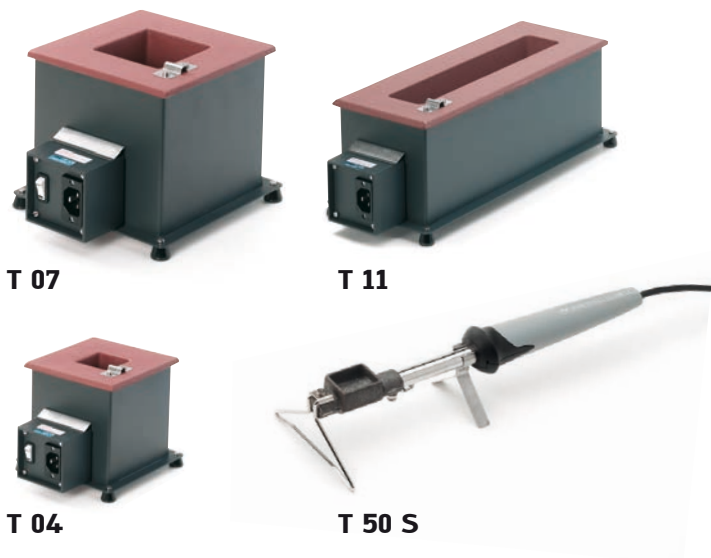

Order no.	Description	Rating/ Voltage	Temperature	Dimensions in mm (L x W x D)	Capacity	Weight	Heating elements
0T55 <b>1T5500A068</b>	Solder bath T 50 S	65 W / 230 V <b>65 W / 115 V</b>	300 °C	28 x 20 x 13	approx. 40 g	370 g	1 pc. 0051T001
0T56 <b>1T5600A068</b>	Solder bath T 10 S	130 W / 230 V <b>130 W / 115 V</b>	340 °C	60 x 30 x 25	approx. 185 g	615 g	1 pc. 0151B0
0T02	Solder bath T 02	240 W / 230 V	600 °C	25 Ø; 47 D	approx. 125 g	1,200 g	1 pc. 0241T0
0T03	Solder bath T 03 <sup>2</sup>	360 W / 230 V	430 °C	100 x 30/15 <sup>1</sup> x 55	approx. 1,000 g	2,300 g	2 pcs. 05X100
0T04	Solder bath T 04	400 W / 230 V	410 °C	52 x 52 x 84	approx. 1,900 g	3,900 g	4 pcs. 05X100A1
0T05	Solder bath T 05	500 W / 230 V	440 °C	86 x 68/20 <sup>1</sup> x 90	approx. 2,850 g	3,400 g	2 pcs. 08X800
0T06	Solder bath T 06	1,000 W / 230 V	560 °C	120 x 80 x 60	approx. 4,800 g	5,200 g	6 pcs. 05X100P2
0T07	Solder bath T 07	1,200 W / 230 V	600 °C	90 x 90 x 100	approx. 6,400 g	5,500 g	4 pcs. 08X800A5
0T11	Solder bath T 11	1,600 W / 230 V	450 °C	300 x 60 x 50	approx. 7,500 g	8,000 g	8 pcs. 05X100A3

1 tapered solder pot;  
2 VDE tested, all other solder baths are produced according to VDE standards

# Ersa temperature regulator RA 4500 D

The **RA 4500 D** temperature regulator can be operated with various solder baths. The solder baths can be connected to the regulator through simple plug connectors. With its five operating programs, the RA 4500 D's easy program selection allows the user to change quickly between different solder baths.

The station can also be used for simple temperature measurements (Pr5) by means of the temperature sensor (option). Its wide variety of features and great control precision (especially with Ersa solder baths) makes the RA 4500 D especially suitable for production processes with high quality requirements.



## RA 4500 D

A microprocessor sets new standards with regard to the temperature regulator's functions and provides comfortable operation of the RA 4500 D. Fig.: RA 4500 D with optionally available temperature sensor 0F008

Order no.	Description	Connected load / voltage	Tolerance	Temperature range	Switch
0RA4500D <b>1RA4500D00A67</b>	Temperature regulator	3,000 W/230 V, 50 – 60 Hz <b>3,000 W/115 V, 50 – 60 Hz</b>	max. ±2 %	50 °C – 600 °C	2-position with P-characteristics
0F007	Temperature sensor, 8 mm Ø				
0F008	Long-life temperature sensor, 3 mm Ø				

# Soldering stations

High-tech soldering and desoldering, diverse applications and high precision: easily attained with Erska top-quality products.

Precise temperature measurement near the soldering tip and a microprocessor controlled heating system guarantee safe lead-free soldering at low temperatures. The high capacity of Erska soldering stations ensures superior reheating. Even high-mass soldering can be carried out without problems.

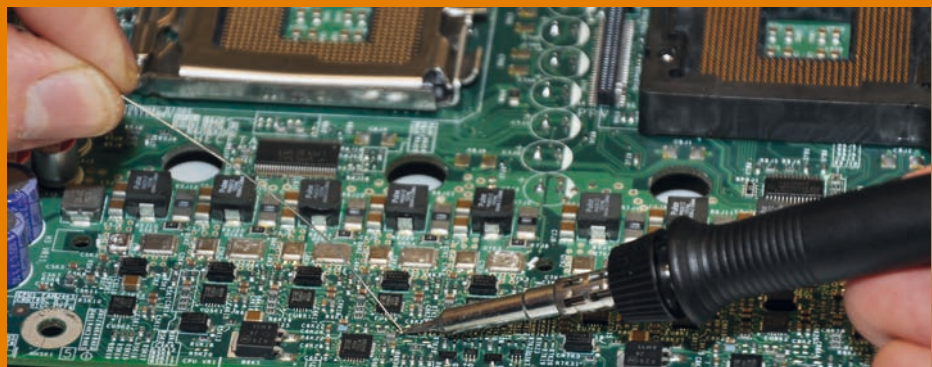

# Ersa RDS 80 soldering station



The Ersa **RDS 80** digital soldering station offers the Ersa RESISTRONIC temperature control, tried and proven for many years and now with **80 W** heating power.

The ceramic PTC heating element (positive temperature coefficient) acts as the temperature sensor in this control system and ensures extremely fast heating thanks to the high initial output.

High heating power and the large selection of soldering tips allow a very wide range of applications. The heating system with the internally heated soldering tips has a high thermal efficiency.

The redesigned ergonomic handle, the housing design and the large, digital multifunctional display do not leave much to be desired.

Besides the arbitrary temperature selection between 150 °C and 450 °C, three fixed temperatures or two fixed temperatures and one standby temperature can be programmed.

In addition to a power bar graph display the station also has a calibrating and power-off feature. The potential equalization socket (with an integrated 220 kΩ resistor) allows the soldering tip to be equalized with the workplace potential.

The RT 80 soldering iron has a sprayed-on, flexible PVC connecting cable.

For tip exchange we recommend to use the tip exchanger 3ZT00164 (see page 32).



**Super price-performance ratio**

## RDS 80

with RT 80 soldering iron, Ersa RESISTRONIC control system  
**Soldering tip series 832 and 842** see page 40

RT 80: very slim soldering iron featuring a large selection of soldering tips



Potential equalization socket



Application example



Multifunctional display

# Ersa ANALOG 60/60 A soldering stations



The electronically temperature-controlled **ANALOG 60** soldering station is the basic model of the Ersa soldering station series. It has the tried and proven Ersa RESISTRONIC temperature control technology, with the ceramic PTC heating element serving as the temperature sensor. The high initial power enables fast heat-up.

The large selection of soldering tips allows a broad range of applications. The internal heating provides high thermal efficiency. A front-installed socket with integrated, high-impedance allows potential equalization between the soldering tip and the workplace.

The device is primarily used for smaller and medium-sized solder joints. The low-voltage operated soldering iron BASIC TOOL 60 has a highly flexible, heat-resistant connecting cable.

The electronically temperature-controlled Ersa **ANALOG 60 A** soldering station is antistatic according to the MIL-SPEC / ESA standard and has all the positive features of the Ersa ANALOG 60.

The light and slim ERGO TOOL soldering iron has a highly flexible, heat-resistant and antistatic connecting cable.

The ANALOG 60 A soldering station is especially suitable for producing small and medium-sized solder joints.

For tip exchange we recommend to use the tip exchanger 3ZT00164 with an additional flat nose pliers and side cutter (see page 32).



Application example



## ANALOG 60

with BASIC TOOL 60 soldering iron, Ersa RESISTRONIC control system  
**Soldering tip series 832 and 842** see page 40



## ANALOG 60 A

with ERGO TOOL soldering iron, Ersa RESISTRONIC control system  
**Soldering tip series 832 and 842** see page 40



Order no.	Description	Rating/voltage	Heating time	Temperature range	Weight (with cable)
0RDS80	RDS 80 soldering station, complete, with RT 80 soldering iron 0890CDJ,	80 W/230 V, 50 – 60 Hz/24 V 105 W (280 °C)	approx. 40 s (280 °C)	150 °C – 450 °C	approx. 130 g
<b>1RDS800000A67</b>	soldering tip 0842CD and tool holder 0A39	<b>80 W/115 V, 50–60 Hz/24 V, 105 W (280 °C)</b>			
0ANA60	ANALOG 60 soldering station, complete, with BASIC TOOL 60 soldering iron 0670CDJ, with soldering tip 0832CDLF and tool holder 0A42	60 W/230 V, 50 – 60 Hz/24 V 60 W (350 °C)	approx. 60 s (280 °C)	150 °C – 450 °C	60 g
<b>1ANA600000A67</b>		<b>60 W/115 V, 50–60 Hz/24 V, 60 W (350 °C)</b>			
0ANA60A	ANALOG 60 A soldering station, complete, with ERGO TOOL soldering iron 0680CDJ, with soldering tip 0832CDLF and tool holder 0A42	60 W/230 V, 50 – 60 Hz/24 V 60 W (350 °C)	approx. 60 s (280 °C)	150 °C – 450 °C	60 g
<b>1ANA60A000A67</b>		<b>60 W/115 V, 50–60 Hz/24 V, 60 W (350 °C)</b>			

# i-CON soldering/desoldering stations

Ersa i-CON – innovative technology for efficient and comfortable hand soldering



Ensuring quality in lead-free soldering is a huge challenge for hand soldering. Consequently the users have a wide range of requirements a modern hand soldering tool should meet: It should be small, light-weight and ergonomic. It may not become too hot during the soldering process. And it has to provide high power and efficiency for fast heat-up and recovery during soldering. In addition, tip exchange should be quick and easy, and the station's operation and programming should be simple and user-friendly.

The stations of the Ersa i-CON series fully comply with these requirements. Various models are available that all convince with innovative technology – from the smallest and cheapest station, the i-CON PICO, up to the new flagship, the i-CON VARIO 4. Low-cost exchangeable tips and the intelligent standby function provide for low operating costs, high economic efficiency and considerable energy savings.

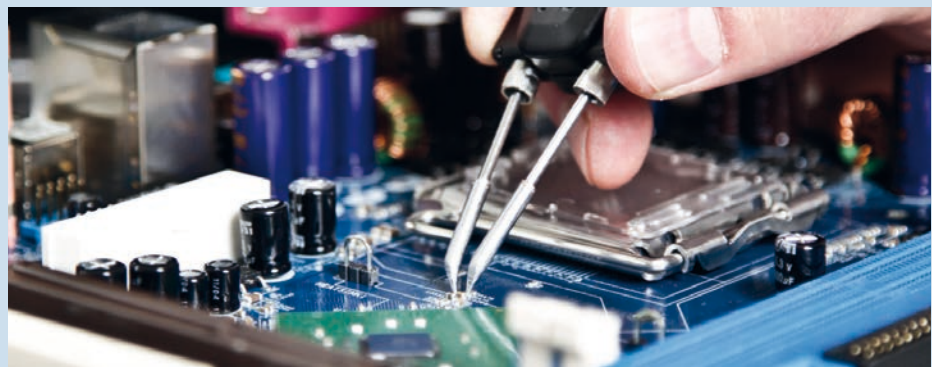

# Ersa i-CON: innovative lead-free hand soldering

The engineering goal behind the i-CON was to invent a new soldering iron which outperforms the competitive tip-cartridge irons and works with low-cost, exchangeable tips at the same time.

Mission accomplished: Ersa's 150 W i-TOOL clearly exceeds the market's expectations for a high-powered, micro soldering iron with low-cost tips. The i-TOOL „Silver Bullet“ heating element represents the most significant heating element design accomplishment in Ersa's over 90-year-history.

With its rapid recovery and ultra low weight i-TOOL (approx. 30 gr.), the extensive i-TIP soldering tip range, as well as the Process Window Alarm, Energy Levels and Motion Sensor for Auto-Sleep functions, i-CON users worldwide are benefiting from the highest level of process control ever seen in the industry.

Tremendous savings in tip costs make this line even more attractive. The extensive range of standard and special tips offers an unparalleled level of flexibility even for the most difficult and unconventional applications.

The i-CON product range is antistatic and includes both single and double iron stations for use of various soldering and desoldering tools. Equipped with an interface, the i-CON C stations can additionally control peripheral systems such as fume extractions or heating plates.



1. Low-cost i-TIP (consumable, easy to change, long-life)
2. i-TIP fastener, available in black or green
3. High-power heating element (stick-on type, long-life)



i-TOOL soldering iron: ultra light (only 30 grams), ultra short (only 155 mm), and ultra short tip-to-grip (only 45 mm).



The i-TOOL has a highly advanced PCB integrated into the handle for a level of intelligence never before seen in a soldering iron.

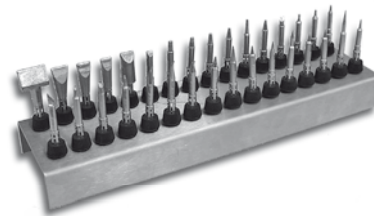

Wide range of soldering tips, series 102

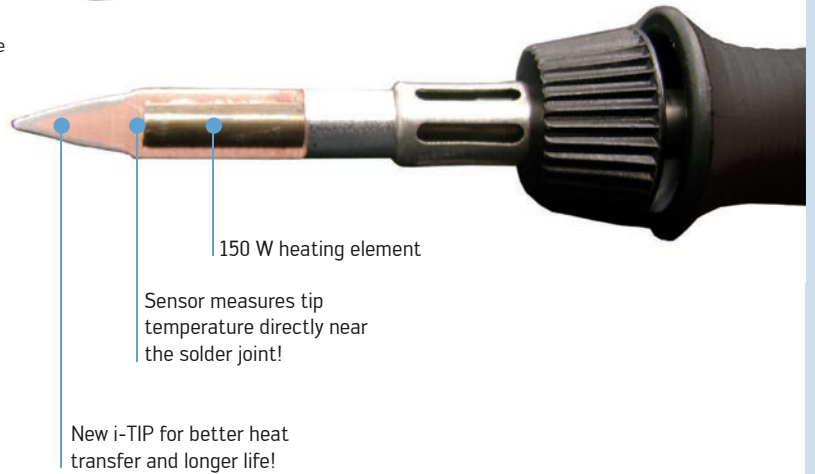
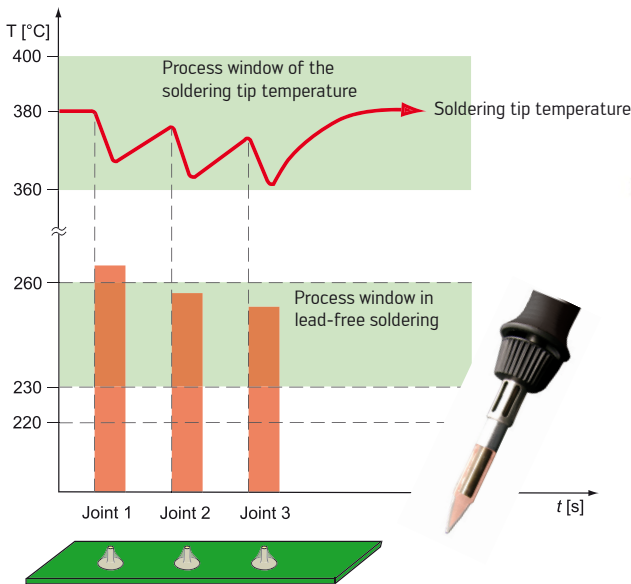

150 W heating element  
Sensor measures tip temperature directly near the solder joint!  
New i-TIP for better heat transfer and longer life!

The i-TOOL recovers so fast that all solder joints can be made with nearly the same temperature. The sensor measures the actual tip temperature very close to the tip extremity. The Process Window Alarm enables a repeatable soldering quality for the operator.

Ersa has succeeded in designing one of the smallest, lightest and most powerful soldering irons in the world – the Ersa i-TOOL. The true value added for our customers lies not only in the fact that it will increase both the hand soldering quality and productivity, but also in a tremendous reduction of operational costs associated with manual soldering.

Ersa's new technology offers – compared to the soldering irons with expensive heating cartridge tips – a standard low-cost, long-life exchangeable tip for a similar performance!

The Ersa i-CON advanced digital power supply offers Ersa's "One Touch" easy-to-use operation with the new i-Op Control, as well as numerous value added functions.

### Power level settings:

Three different power level settings are available which control the heating element overshoot depending on the heat required.

Thus, the operator can choose the right setting for the right job – either more power or more control! Power level "Low" guarantees no overshoot for maximum component safety!

### Process window and alarm:

Signals the operator if the temperature leaves the pre-set process window.

### Automatic standby:

Recognizes when the iron is not used and automatically reduces the temperature to a standby temperature after expiration of a pre-determined standby time.

### i-TOOL calibration:

Unlike other systems, the microprocessor which stores the temperature calibration of the iron is actually located in the PCB which is installed in the handle. This now allows for each individual i-TOOL to be calibrated independent of the station.

## Ersa i-CON soldering stations with interface: one control unit for preheating, soldering, fume extraction

The most exciting aspect of the i-CON C is its capability to control the two most important peripheral systems on the workbench – the Ersa IR heating plate and the Ersa EASY ARM fume extraction systems. All hand soldering tasks can be handled more rapidly and more safely when the assembly is preheated during the touch-up.

The proven IR heating plate technology which comes directly out of Ersa's world renowned IR rework product line offers bottom-side preheating for hand soldering, desoldering and touch-up applications. The safe yet powerful medium wavelength IR preheating system offers a tremendous benefit to today's workbench: Working temperatures of the soldering iron, heated SMD tweezers and/or desoldering iron can be greatly reduced. Lower tip temperatures decrease the

risk of PCB damage while at the same time greatly increasing tip lifetime!

Finally, the intelligent fume extraction units Ersa EA 1 and EA 2 are compact and powerful systems to efficiently clean soldering process air at the workbench. Combined with up to two i-CON1 C or i-CON2 VC soldering stations, connected with an interface cable, these filter systems open up a completely new dimension of intelligent solder fume filtration. The extraction unit is only working while at least one of the attached soldering

stations is in operation. When both i-CON units rest in the standby mode, the EA 1 or EA 2 will automatically switch off.

Filter usage times will increase, energy costs and operation noise level will be significantly reduced to a minimum.

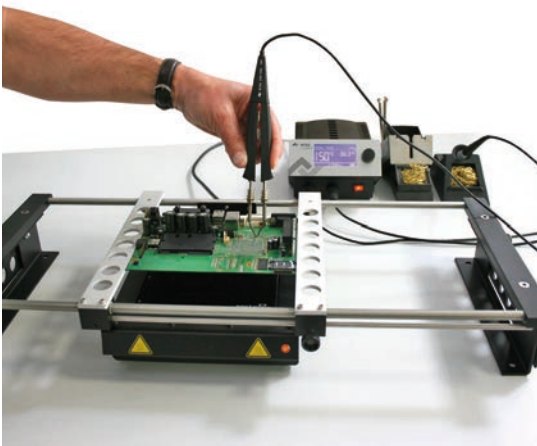

SMD desoldering with the CHIP TOOL desoldering tweezers. Bottom-side preheating of the PCB with a heating plate provides for gentle processes.



Fully equipped i-CON2 VC workplace with i-CON2 VC station, i-TOOL, CHIP TOOL VARIO and solder fume extraction

## Ersa i-CON: safe and innovative lead-free hand soldering

### i-CON Matrix

i-CON station / tools + peripherals								
i-CON control stations	i-TOOL	i-TOOL AIR S	i-TOOL HP	CHIP TOOL	CHIP TOOL VARIO	X-TOOL VARIO *	IR heating plate	EASY ARM 1+2
i-CON1	●							
i-CON1 V	●			●	●	●		
i-CON2 V	●			●	●	●		
i-CON1 C	●						●	●
i-CON1 VC	●			●	●	●	●	●
i-CON2 VC	●			●	●	●	●	●
i-CON VARIO 2	●	●	●	●	●	●	●	●
i-CON VARIO 4	●	●	●	●	●	●	●	●

\*A vacuum station is required to operate this tool with an i-CON control station (except i-CON VARIO stations).



# Ersa i-CON PICO soldering station



The **i-CON PICO** station offers the beginner all essential features of a soldering station, such as fastest heat-up and heat recovery, standby function and calibration mode. Due to the i-CON PICO's simple and user-friendly operating concept, the factory settings provide for a variable adjustment of operating temperature as well as setting of standby time and calibration value. Using the free-of-charge PC software and by an optional micro smart SD card further setting options like fixed temperatures, energy level, interlock and shutdown functions are available.

The technological master plan of the i-CON PICO assures that the optimal parameters are used for each application. Hereby the i-CON PICO stands for highest process stability and quality control at low investment costs and operation expenses. The automatic standby and shutdown function provide for energy savings and an increased tip lifetime.

The i-CON PICO comes fully equipped with the i-TOOL PICO soldering iron. This ultra-light and powerful iron uses exactly the same heating element technology as his larger brothers of the Ersa i-TOOL family. A wide range of cost-effective soldering tips is available for the i-TOOL line.



**Small footprint only 145 mm x 80 mm!**

## i-CON PICO

with i-TOOL PICO soldering iron  
**Soldering tip series 102** see page 38/39

## i-CON PICO

Software download: [www.ersa.com/pico](http://www.ersa.com/pico)



Order no.	Description	Dimensions (L x W x H)	Rating/voltage	Heating time	Temperature range
01C1300	i-CON PICO soldering station, complete, with i-TOOL PICO (0130CDK) soldering iron with soldering tip 0102CDLF16 and holder 0A53.	145 x 80 x 103 mm	max. 80 W/230 V, 50 Hz, max. 80 W 220 – 240 VAC <b>max. 80 W/115 V, 60 Hz</b>	9 s	150 °C – 450 °C

**11C1300000A67**

# Ersa i-CON NANO soldering station



The fully antistatic **i-CON NANO** soldering station satisfies all needs of today's industrial manufacturing requirements combined with lowest space requirement. It is predestined for the continuous operation in electronic production as well as for special applications in laboratories and development.

Due to the i-CON NANO's simple and user-friendly operating concept, the factory settings provide for a variable adjustment of operating temperature as well as setting of standby time and calibration value.

Using the free-of-charge PC software and by an optional micro smart SD card further setting options like fixed temperatures, energy level, interlock and shutdown functions are available.

The technological master plan of the i-CON NANO assures that the optimal parameters are used for each application. Hereby the i-CON NANO stands for highest process stability and quality control with regard to low investment costs and operation expenses.



**Small footprint only 145 mm x 80 mm!**

## i-CON NANO

with i-TOOL NANO soldering iron  
**Soldering tip series 102** see page 38/39



Micro SD card with SD card and USB adapter

## i-CON NANO

Software download: [www.ersa.com/nano](http://www.ersa.com/nano)

Order no.	Description	Rating/voltage	Heating time	Temperature range	Weight
01C1200A	i-CON NANO soldering station, complete, with i-TOOL NANO soldering iron (0120CDK), soldering tip 0102CDLF16 and holder 0A52 with dry sponge 0008M	max. 80 W / 230 V, 50 Hz, max. 80 W <b>max. 80 W / 115 V, 60 Hz,</b>	approx. 9 s (350 °C)	150 °C – 450 °C	approx. 30 g
<b>11C1200A00A67</b>					
01C128	Micro SD card with i-CON NANO software and card reader				

## Ersa i-CON1 soldering station

The **i-CON1** is the popular and proven "workhorse" for electronics production. It comes with the lightweight and ergonomic 150 W i-TOOL soldering iron – the perfect tool for all SMD and THT applications. The comprehensive 102 tip series enables the i-TOOL to be perfectly set for each job.

The digital i-CON1 control station features the modern "One-Touch" operating concept with i-Op control and large, backlit plain text display. The version with interface provides for the connection of an IR heating plate and a solder fume extraction system.



### i-CON1

with i-TOOL soldering iron with micro heating element  
**Soldering tip series 102** see page 38/39

Order no.	Description	Rating/ voltage	Heating time	Temperature range	Weight (w/o cable )
01C1100A	i-CON1 electronic station complete with i-TOOL soldering iron 0100CDJ with soldering tip 0102CDLF16, holder 0A52 and dry sponge 0008M	150 W/230 V, 50 Hz	approx. 9 s (350 °C)	150 °C – 450 °C	approx. 30 g
<b>11C1100A00A67</b>		<b>150 W/115 V, 60 Hz</b>			
01C1100A0C	i-CON1 C electronic station with D-Sub connector, complete with i-TOOL soldering iron 0100CDJ with soldering tip 0102CDLF16, holder 0A52 and dry sponge 0008M	150 W/230 V, 50 Hz	approx. 9 s (350 °C)	150 °C – 450 °C	approx. 30 g
<b>11C1100A0CA67</b>		<b>150 W/115 V, 60 Hz</b>			

## Ersa i-CON1 V soldering and desoldering station

With the model **i-CON1 V**, Ersa has revised its i-CON soldering station series and also expanded functions. The i-CON1 V features the new control technology users already know from the i-CON VARIO stations.

It is now possible to operate the new soldering and desoldering tools CHIP TOOL VARIO and X-TOOL VARIO. Furthermore, already existing soldering tools, such as the POWER TOOL for example, can be used with this station. Consequently, the operator can select from a total of eight tools for different soldering and desoldering applications.

To provide the necessary vacuum for the X-TOOL VARIO, Ersa offers a vacuum station to be connected to the i-CON1 V station.



Order no.	Description	Rating/ voltage	Heating time	Temperature range	Weight (w/o cable )
01C1100V	i-CON1 V soldering and desoldering station, complete, with i-TOOL soldering iron 0100CDJ with soldering tip 0102CDLF16 and holder 0A52	80 W/230 V, 50 Hz 150 W	approx. 9 s (350 °C)	50 °C – 450 °C	approx. 30 g
<b>11C1100V00A67</b>		<b>150 W/115 V, 60 Hz</b>			
01C1100VCV	i-CON1 V soldering and desoldering station, complete, with CHIP TOOL VARIO desoldering tweezers 0460MDJ with tips 0462MDLF007, holder 0A54	80 W/230 V, 50 Hz 2 x 20 W (350 °C)	subject to tips	50 °C – 450 °C	approx. 75 g
<b>11C1100VCVA67</b>		<b>150 W/115 V, 60 Hz</b>			
01C1100VXT	i-CON1 V soldering and desoldering station, complete, with vacuum station 0CU103A, X-TOOL VARIO desoldering iron 0740EDJ with tip 0742ED1225, holder 0A56	80 W/230 V, 50 Hz 45 W 150 W	subject to application	50 °C – 450 °C	approx. 210 g
<b>11C1100VXTA67</b>		<b>150 W/115 V, 60 Hz</b>			
01C1100V0C	i-CON1 V soldering and desoldering station with interface, complete, with i-TOOL soldering iron 0100CDJ with tip 0102CDLF16, holder 0A52	80 W/230 V, 50 Hz 150 W	approx. 9 s (350 °C)	50 °C – 450 °C	approx. 30 g
<b>11C1100V0CA67</b>		<b>150 W/115 V, 60 Hz</b>			

# Ersa i-CON2 V double channel soldering and desoldering station – a plus in flexibility for professionals

The double channel soldering and desoldering station **i-CON2 V** is a consistent further development of the well-known i-CON2 based on the future-oriented Ersa VARIO platform.

In addition to the present soldering and desoldering tools, the station can also drive the SMD desoldering tweezers **CHIP TOOL VARIO** (2 x 40 W) and the **PTH desoldering iron X-TOOL VARIO** (150 W). The station utilizes an intelligent power management to shift dynamically its power between the attached tools. The i-CON2 V, like all other i-CON stations, convinces by its intuitive One-Touch operation and the large multifunctional display. The station meets the ESD requirements and is available in a version with interface to connect a fume extraction unit, a heating plate and a PC. If required, the i-CON2 V can be updated like the i-CON VARIO stations with a microSD memory card and thus is prepared for future necessities.



## X-TOOL VARIO

Powerful desoldering iron for safe desoldering of heat-sensitive through-hole components, temperature range 150 °C – 450 °C

**Desoldering tip series 742** see page 46



## CHIP TOOL VARIO

CHIP TOOL VARIO desoldering tweezers, temperature range 150 °C – 450 °C

**Desoldering tip pairs of the series 462** see page 42

Order no.	Description	Rating/ voltage	Heating time	Temperature range	Weight (w/o cable)
01C2200V	Double channel soldering and desoldering station i-CON2 V, complete, with i-TOOL soldering iron 0100CDJ with soldering tip 0102CDLF16	150 W/230 V, 50 Hz 150 W	approx. 9 s (350 °C)	50 °C* – 450 °C*	approx. 30 g
<b>11C2200V00A67</b>	and holder 0A52, complete	<b>150 W/115 V, 60 Hz</b>			
01C2200VC	Double channel soldering and desoldering station i-CON2 V, complete, with i-TOOL soldering iron 0100CDJ with soldering tip 0102CDLF16	150 W/230 V, 50 Hz 150 W	approx. 9 s (350 °C)	50 °C* – 450 °C*	approx. 30 g
	CHIP TOOL VARIO desoldering tweezers 0460MDJ with tips	2 x 20 W (350 °C)	subject to tips		approx. 75 g
<b>11C2200VC0A67</b>	0462MDLF007, holders 0A52 and 0A54, complete	<b>150 W/115 V, 60 Hz</b>			
01C2200VIT	Double channel soldering and desoldering station i-CON2 V, with 2 i-TOOL soldering irons 0100CDJ with soldering tip 0102CDLF16, and 2 holders 0A52, complete	150 W/230 V, 50 Hz 150 W	approx. 9 s (350 °C)	50 °C* – 450 °C*	approx. 30 g
<b>11C2200VITA67</b>		<b>150 W/115 V, 60 Hz</b>			
01C2200VXT	Double channel soldering and desoldering station i-CON2 V, complete, with vacuum unit 0CU103A	150 W/230 V, 50 Hz 45 W		50 °C* – 450 °C*	
	i-TOOL soldering iron 0100CDJ with tip 0102CDLF16,	150 W	approx. 9 s (350 °C)		approx. 30 g
	X-TOOL VARIO desoldering iron 0740EDJ with tip 0742ED1225, holders 0A52 and 0A56, complete	150 W	subject to application		approx. 210 g
<b>11C2200VXTA67</b>		<b>150 W/115 V, 60 Hz</b>			
01C2200VOC	Double channel soldering and desoldering station i-CON2 V, complete, with interface	150 W/230 V, 50 Hz		50 °C* – 450 °C*	
	i-TOOL soldering iron 0100CDJ with tip 0102CDLF16, and holder 0A52, complete	150 W	approx. 9 s (350 °C)		approx. 30 g
<b>11C2200V0CA67</b>		<b>150 W/115 V, 60 Hz</b>			

\* using i-TOOL

## Ersa i-CON VARIO 2 multi-channel station

The **i-CON VARIO 2** multi-channel soldering and desoldering station can operate two soldering tools at the same time. In addition to the i-TOOL AIR S hot air iron (200 W) the user can plug in the i-TOOL soldering iron (150 W) for classical soldering applications or the new CHIP TOOL VARIO desoldering tweezers (2 x 40 W). Alternatively the i-CON VARIO 2 can operate further Ersa soldering tools.

Just like any other i-CON model the compact and ESD safe station offers the well-known simple and clear "i-CON operability". And just like the larger i-CON VARIO 4, the i-CON VARIO 2 comes standard with interfaces for the Ersa solder fume extraction units and heating plates. The simple and safe configuration with a micro SD memory card is a further standard feature of the i-CON VARIO 2.

### i-CON VARIO 2

Antistatic multi-channel soldering and desoldering station with i-TOOL AIR S hot-air iron and CHIP TOOL VARIO desoldering tweezers, order no. 01CV2000AC.



## Choose your configuration from 5 professional i-CON VARIO tools

### i-TOOL AIR S

Ergonomic, handy, strong in performance – that is an apposite description of the i-TOOL AIR S. The slim and light handle holds a heating cartridge with 200 W power permitting the user to process a wide range of SMDs in a non-exhausting way. The hot-air volume can be adjusted very easily directly on the handle, and the set air volume (2 – 20 l/min) is clearly visible on the display of either the i-CON VARIO 2 or the i-CON VARIO 4. Various nozzle sizes are available for an optimal component heat-up.



#### i-TOOL AIR S

i-TOOL AIR S hot-air iron  
Hot-air nozzle series 472 see page 43

### i-TOOL HP

Full power for challenging soldering jobs! The i-TOOL HIGH POWER is a high-performance 250 W soldering iron for particularly demanding and high-mass soldering applications which was developed especially for the i-CON VARIO stations. Despite its high rating the i-TOOL HIGH POWER is a light-weight tool weighing only 110 g; the ergonomic handle and a standby sensor assure efficient working in a non-exhausting way. Tip exchange is as quick and easy as with the i-TOOL soldering iron.



#### i-TOOL

i-TOOL soldering iron with micro heating element  
Soldering tip series 102 see page 38/39



#### i-TOOL HP

High-performance soldering iron i-TOOL HP, temperature range 150 °C – 450 °C  
Soldering tip series 242 see page 41

### CHIP TOOL VARIO

The CHIP TOOL VARIO stands out by its high power (2 x 40 W) and its very compact design. Thus it is perfectly suited for working on very small and delicate SMD components. The heating element pairs are plug-in components. They can be aligned exactly in the handle, and exchanging them is quick and easy. Furthermore, the operating mode of this precision tool can be set from self-closing mode to self-opening mode with an integrated switch. The CHIP TOOL VARIO is equipped with the proven and reliable motion sensor to activate it out of standby.



#### CHIP TOOL VARIO

CHIP TOOL VARIO desoldering tweezers, temperature range 150 °C – 450 °C  
Desoldering tip pairs of the series 462 see page 42

### X-TOOL VARIO

The new X-TOOL VARIO convinces with highly efficient 150 W heating technology. The design of heating element and desoldering tip ensure an efficient thermal transfer and a fast evacuation of the extracted solder. For users the ergonomic handle means relaxed working with a healthy hand position. The slim shape of heating head and desoldering tip allow desoldering even on tightly packed PCBs.



#### X-TOOL VARIO

X-TOOL VARIO – powerful desoldering iron for safe desoldering of heat-sensitive through-hole components, temperature range 150 °C – 450 °C  
Desoldering tip series 742 see page 46

# Ersa i-CON VARIO 4 multi-channel station



## i-CON VARIO 4

Antistatic multi-channel soldering and desoldering station with i-TOOL AIR S hot-air iron, CHIP TOOL VARIO desoldering tweezers, X-TOOL VARIO desoldering iron, i-TOOL HP high-performance soldering iron and i-TOOL soldering iron. Order no. 01CV4000AICXV



The **i-CON VARIO 4** multichannel soldering and desoldering station meets highest demands in the field of professional soldering and desoldering. It is the i-CON family's flagship. The user can connect and operate up to 4 tools at the same time: the ergonomic i-TOOL AIR S hot air iron with 200 W for flexible soldering and desoldering with non-contact energy transfer; the i-TOOL with 150 W for efficient soldering; the 250 W i-TOOL HP for demanding high-mass applications, the new CHIP TOOL VARIO with 80 W for precise desoldering of most delicate SMDs and the X-TOOL VARIO with 150 W for desoldering through-hole components. Alternatively the i-CON VARIO 4 can operate further Ersa soldering tools.

All functions, including air and vacuum units, are integrated in the central supply unit featuring Ersa's well-known i-Op operation and clearly arranged displays. Furthermore the station has interfaces to connect Ersa solder fume extraction units or infrared heating plates as well as a USB port. The configuration of the station is quick and easy via micro SD card leaving it optimally prepared for all applications in professional electronics production. The i-CON VARIO 4 is perfectly suited for the use in ESD protected zones.

Order no.	Description	Rating/voltage	Vacuum	Air flow	Temperature range	Weight (w/o cable)	
01CV403A	i-CON VARIO 4	max. 500 W/230 V, 50 Hz	max. 700 mbar	2 – 20 l/min	50 – 450 °C		
<b>11CV403A00A67</b>	electronic station	<b>max. 500 W/115 V, 60 Hz</b>			(50 – 550 °C – i-TOOL AIR S)		
01CV203A	i-CON VARIO 2	max. 200 W/230 V, 50 Hz		2 – 20 l/min	50 – 450 °C		
<b>11CV203A00A67</b>	electronic station	<b>max. 200 W/115 V, 60 Hz</b>			(50 – 550 °C – i-TOOL AIR S)		
01CV203AP	i-CON VARIO 2	max. 200 W/230 V, 50 Hz	max. 700 mbar	2 – 20 l/min	50 – 450 °C		
<b>11CV203AP1A67</b>	electronic station	<b>max. 200 W/115 V, 60 Hz</b>			(50 – 550 °C – i-TOOL AIR S)		
01CV203HP	i-CON VARIO 2	max. 200 W/230 V, 50 Hz			50 – 450 °C		
<b>11CV203HP0A67</b>	electronic station	<b>max. 200 W/115 V, 60 Hz</b>					
0470BRJ	i-TOOL AIR S hot-air iron	200 W			50 – 550 °C	approx. 90 g	
0100CDJ	i-TOOL soldering iron	150 W			50 – 450 °C	approx. 30 g	
0240CDJ	i-TOOL HP soldering iron	250 W			150 – 450 °C	approx. 110 g	
0460MDJ	CHIP TOOL VARIO desoldering tweezers	2 x 40 W			150 – 450 °C	approx. 75 g	
0740EDJ	X-TOOL VARIO desoldering iron	150 W			150 – 450 °C	approx. 210 g	
01CV207	VARIO TOOL ADAPTER to plug the i-TOOL, X-TOOL VARIO or CHIP TOOL VARIO into socket A2 of the electronic station						

Contents/order no.	01CV2000A	01CV2000AI	01CV2000AC	01CV2000AXV	01CV2000HP	01CV4000A	01CV4000AI	01CV4000AIC	01CV4000AICXV
i-TOOL AIR S	●	●	●	●		●	●	●	●
i-TOOL		●					●	●	●
i-TOOL HP					●				
CHIP TOOL VARIO			●					●	●
X-TOOL VARIO				●					●

# Ersa soldering station DIGITAL 2000 A



The Ersa **DIGITAL 2000 A** is a top-class microprocessor controlled soldering station distinguished by its flexibility and multifunctionality. It is antistatic according to the MILSPEC/ESA standard and designed for industrial use where high quality is demanded and for repairs and laboratory applications.

The station can alternatively be operated with various soldering and desoldering tools. Besides the **POWER TOOL** and **TECH TOOL** universal soldering irons, the **MICRO TOOL** microsoldering iron and the **CHIP TOOL** desoldering tweezers can be connected.

The tools are automatically detected when inserted, and the control characteristics are adapted accordingly. The soldering and desoldering tips are then always connected with high impedance to the front-installed potential equalization socket.

By just three buttons and a simple menu guide the desired temperatures, the unit of temperature (°C/°F), the standby time of 0 to 60 minutes, a tip offset and calibration feature and a three-character password-controlled lock can all be set.

The calibration feature allows the actual soldering tip temperature to be precisely adjusted to the temperature shown in the LED display. For this purpose a suitable soldering tip temperature measuring device, such as the Ersa DTM series (see page 31), is required.

The Ersa DIGITAL 2000 A soldering station regulates the temperature through a digital PID algorithm, optimized for very precise and fast temperature control.

All connectable soldering and desoldering devices have enormous power reserves thanks to the PTC heating elements located inside the tips.

At a tip temperature of 280 °C the following power is available, for example:

- POWER TOOL – 105 W
- TECH TOOL – 70 W
- MICRO TOOL – 30 W
- CHIP TOOL – 2 x 30 W

All soldering and desoldering tools are operated at the low voltage of 24 V and have a highly flexible, heat-resistant and antistatic connecting cable.

For tip changes we recommend the tip exchanger 3ZT00164 with flat nose pliers and side cutter (see page 32).



## DIG20A84

with **POWER TOOL** soldering iron and Ersa **SENSOTRONIC** control system  
**Soldering tip series 832 and 842** see page 40, fig. with 0A08MSET



## POWER TOOL

with Ersa **SENSOTRONIC** control system  
**Soldering tip series 832 and 842** see page 40



## TECH TOOL

with Ersa **SENSOTRONIC** control system  
**Soldering tip series 612** see page 41



## MICRO TOOL

with Ersa **RESISTRONIC** control system  
**Soldering tip series 212** see page 42



## CHIP TOOL

with Ersa **RESISTRONIC** control system  
**Desoldering tip series 422/452** see page 43

Order no.	Description	Rating/ Voltage	Heating time	Temperature range	Weight (w/o cable )
0DIG20A84	DIGITAL 2000 A electronic station, complete, with POWER TOOL soldering iron 0840CDJ with	80 W/230 V, 50 – 60 Hz/24 V		50 °C – 450 °C	1.25 kg
<b>1DIG20A840A67</b>	soldering tip 0842CDLF and holder 0A42, complete	80 W (350 °C)	approx. 40 s (280 °C)		approx. 50 g
0DIG20A64	DIGITAL 2000 A electronic station, complete, with TECH TOOL soldering iron 0640ADJ with	80 W/230 V, 50 – 60 Hz/24 V		50 °C – 450 °C	
<b>1DIG20A640A67</b>	soldering tip 0612ADLF and holder 0A42, complete	80 W (350 °C)	approx. 12 s (280 °C)		approx. 50 g
0DIG20A27	DIGITAL 2000 A electronic station, complete, with MICRO TOOL soldering iron 0270BDJ with	80 W/230 V, 50 – 60 Hz/24 V		150 °C – 450 °C	
<b>1DIG20A270A67</b>	soldering tip 0212BDLF and holder 0A42, complete	20 W (350 °C)	approx. 50 s (280 °C)		approx. 25 g
0DIG20A45	DIGITAL 2000 A electronic station, complete, with CHIP TOOL desoldering tweezers 0450MDJ with	80 W/230 V, 50 – 60 Hz/24 V		150 °C – 450 °C	
<b>1DIG20A450A67</b>	tips 0452MDLF020 and holder 0A43, complete	2 x 20 W (350 °C)	subject to tips		approx. 75 g
		<b>80 W/115 V, 50 – 60 Hz/24 V</b>			

## Ersa tip holders

The tip holders **SMD 8012**, **SMD 8013** and **SMD 8014** are equipped with the latest soldering tips or desoldering tip pairs, in particular for SMD technology. Tips can be stored neatly arranged in a space-saving way for quick access.

The range of soldering tips and desoldering tip pairs with the component-specific dimensions can be found on pages 38, 39, 42 and 43.

All soldering tips and desoldering tip pairs are manufactured according to the ERSADUR process. They have excellent thermal conductance and a long service life.



**SH 03**  
tip holder, unequipped



**SMD 8012**  
tip holder, complete



**SMD 8013**  
tip holder, complete



**SMD 8014**  
tip holder, complete

Order no.	Description	Equipped with ERSADUR soldering tips	Equipped with ERSADUR desoldering tips
0SH03	tip holder SH 03, unequipped	none	none
0SMD8012	tip holder SMD 8012, complete	0212BDLF, ...CDLF, ...EDLF, ...KDLF	0422ED, ...MD, 0452FDLF100, ...FDLF150, ...QDLF125, ...QDLF175, ...QDLF200, ...QDLF250
0SMD8013	tip holder SMD 8013, complete	0212BDLF, ...CDLF, ...EDLF, ...FDLF, ...SDLF, 0212MS, ...GD, ...WD	0422ED, ...MD, ...SD, 0452FDLF100, ...FDLF125, ...FDLF150, ...FDLF175, ...FDLF200, ...QDLF100, ...QDLF175
0SMD8014	tip holder SMD 8014, complete	0102PDLF04, ...PDLF10, ...CDLF12, ...CDLF16, ...WDLF16, ...WDLF23, ...BDLF20 and tip fastener 3IT1045-00 (green version) for i-TOOL, complete	0422SD, 0452EDLF060, ...FDLF100, ...FDLF150, ...MDLF020, ...QDLF100, ...QDLF175

## Ersa HR 100 hybrid rework system

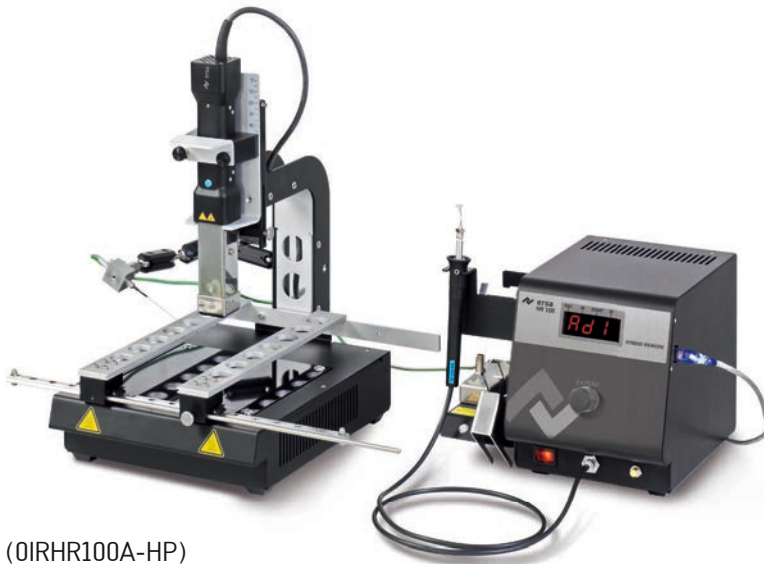

Rapid, simple and safe hand-held component removal

### HR 100 (01RHR100A-HP)

with HYBRID TOOL, VAC-PEN vacuum pipette, 3 hybrid adapters, adapter changer, tool stand for HYBRID TOOL and IR heating plate with PCB holder  
Figure with optional thermocouple and stand.

The **HR 100** uses Ersa's patented Hybrid Rework Technology for safe removal and replacement of components sizing from 0201 chips to 20 x 20 mm SMDs. Safe, medium-wave IR radiation combined with a gentle hot air stream guarantees optimal energy transfer to the component. Exchangeable hybrid adapters focus 200 W of safe hybrid heating power onto the component while protecting neighboring areas from blowing away adjacent chips. The HYBRID TOOL handle contains a positioning laser. The user-friendly operation allows for even

non-experienced operators to handle the HR 100 safely and quickly. Advanced operators using the complete system can not only set air volume and heating power levels, but they can also run and record profiles with the IRSoft rework software!

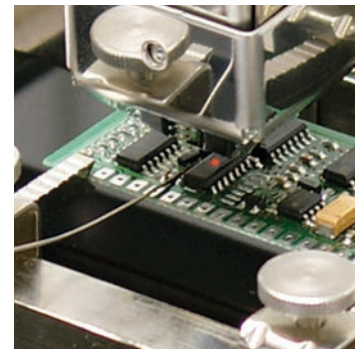

Temperature-controlled SMD soldering

## Ersa HR 200 – Rework out of the Box!



Unpack, setup, solder! It's as simple as that to rework a PCB nowadays. The Ersa **HR 200** hybrid rework system contains a 400 W hybrid highpower heating element to desolder and solder SMT components up to 30 x 30 mm. As an option, the system can operate a powerful 800 W infrared heating plate. This bottom heater guarantees ideal preheating of the assembly to rework.

The operator selects the required power for top and bottom heating with a control knob, each with four levels. A foot switch activates the heating process. The operator's hands are free to remove the desoldered component with appropriate tools.

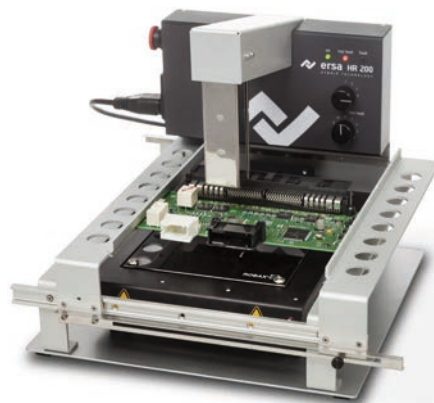

### HR 200 (0HR200-HP)

Hybrid rework system with IR heating plate and PCB holder

Figure without foot switch

Order no.	Description	Rating/voltage	Heated area	Weight (w/o cable)
01RHR100A	HR 100 hybrid rework system, complete, with HYBRID TOOL 31RHR100A-01, VAC-PEN vacuum pipette 0VP020, Hybrid adapters 01RHR100A-14, -15, -16 and adapter changer 01RHR100A-24	200 W/230 V, 50 – 60 Hz	6 x 6 mm to 20 x 20 mm	300 g
<b>11RHR100A0A67</b>		<b>200 W/115 V, 50 – 60 Hz</b>		
01RHR100A-HP	HR 100 hybrid rework system, complete, with HYBRID TOOL 31RHR100A-01, VAC-PEN vacuum pipette 0VP020, three hybrid adapters, adapter changer, HYBRID TOOL holder and IR heating plate with PCB holder	200 W/230 V, 50 – 60 Hz	6 x 6 mm to 20 x 20 mm	300 g
<b>11RHR100AHPA67</b>		<b>800 W/230 V, 50 – 60 Hz</b>	125 x 125 mm	2.5 kg
	Recommended accessories for 01RHR100A:			
01RHR-ST050	Hybrid rework tripod, complete			
0HR200	HR 200 hybrid rework system with foot switch, positioning laser and PCB holder	400 W/230 V, 50 – 60 Hz	30 x 30 mm	3.7 kg
<b>11HR2000000A67</b>		<b>400 W/115 V, 50 – 60 Hz</b>		
0HR200-HP	HR 200 hybrid rework system with foot switch, positioning laser, PCB holder and heating plate	400 W/230 V, 50 – 60 Hz	30 x 30 mm	3.7 kg
		800 W/230 V, 50 – 60 Hz	125 x 125 mm	1.6 kg
<b>11HR200-HP0A67</b>		<b>400 W, 800 W/115 V, 50 – 60 Hz</b>		



## Ersa **DIP&PRINT STATION** for solder paste printing

The user of an Ersa rework system can prepare components (application of solder paste or flux) in an easy, reliable and reproducible manner with the Ersa **DIP&PRINT STATION**.

Optionally available dip stencils permit – using defined parameters – to immerse the components into flux or solder paste, building up a defined depot on the contacts to be soldered. This method is suitable for BGAs and for most fine-pitch components. Using a component specific print stencil, solder paste depots can be easily and precisely be added on QFN/MLF pins, for example, and on pins of other SMD components.

In the printing process, the solder paste is applied from below onto the component fixed in the print stencil. The component is then lifted off the stencil with the placement unit and positioned on the board.

A fitting frame fixation is available for every Ersa rework system to install the DIP&PRINT STATION's stencil frame on the placement unit.

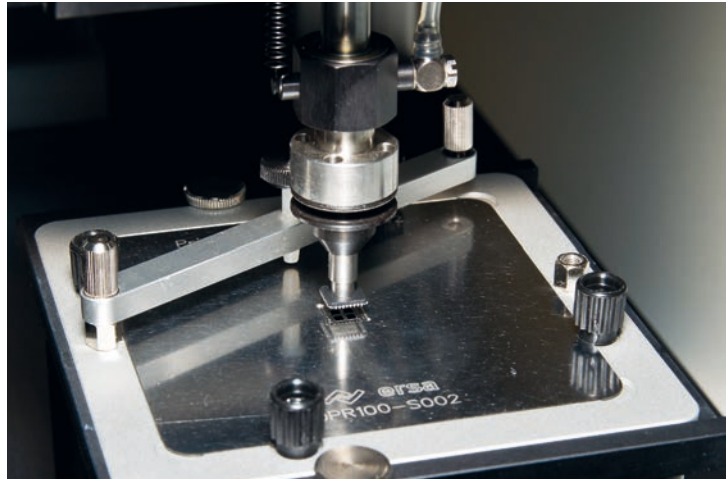

Component is lifted off the print stencil

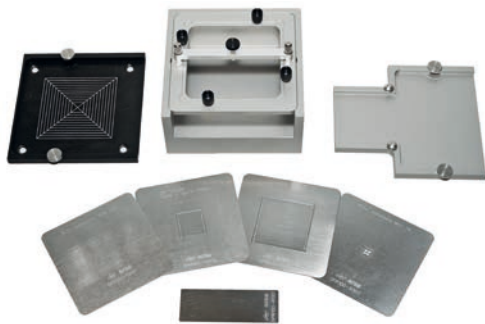

DIP&PRINT STATION with accessories

### Features **DIP&PRINT STATION**

- Easy solder paste printing on the component
- Component dip-in for solder paste or flux
- Fits for every Ersa rework system
- Easy stencil exchange
- Easy cleaning

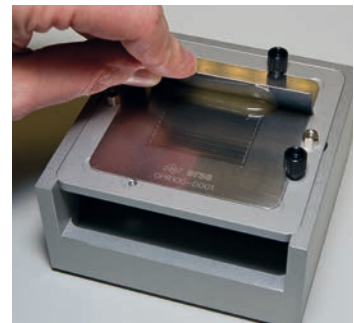

Flux application in a dip stencil

Order no.	Description
OPR100	DIP&PRINT STATION
OPR100-PL550	Frame fixation for PL 550
OPR100-PL650	Frame fixation for PL 650
OPR100-D001	Dip stencil, 40 x 40 mm / 300 µm
OPR100-D002	Dip stencil, 20 x 20 mm / 150 µm
OPR100-D003	Dip stencil, 20 x 20 mm / 100 µm

Connecting pads of SMD components may have tolerances and significant deviations. Therefore, print stencils can only be offered and produced after exact technical review.

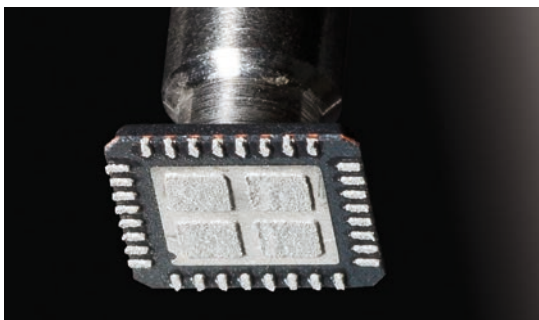

MLF 32 with solder paste printed on the bottom

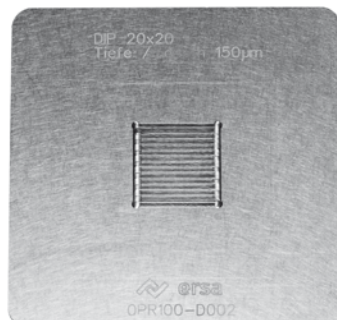

Dip stencil, 20 x 20 mm, 150 µm

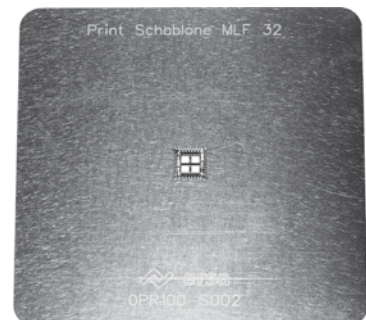

Top side of a MLF 32 print stencil

# CLEAN-AIR solder fume extractions

Noxious gases develop in every soldering process due to the use of fluxes. This aspect, together with the fact that flux condensate on the PCB can cause problems, results in an increased requirement to use solder fume extraction systems, also with regard to quality.



Ersa EASY ARM solder fume extractions ensure clean boards and a healthy environment in an efficient and economic way when hand soldering. They clear off an entire working area via large nozzles which are available in different designs.

The Ersa CLEAN-AIR systems with their robust, long-life metal housings are very compact and flexible in their application. Their noise level is pleasantly low. Due to the intelligent interface for the i-CON C soldering stations, the extraction units automatically switch into standby mode as soon as the station connected does which considerably saves energy costs and resources.

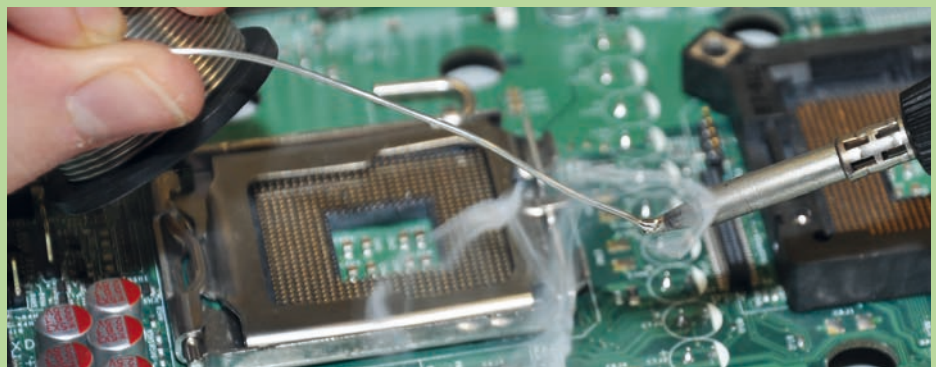

# Ersa EA 1 and EA 2 solder fume extractions



- Technical highlights:**
- Efficient 3-stage particle- and gas filtering
  - Super silent operation
  - Independently adjustable suction power per arm
  - Optical and acoustical filter exchange status
  - Easy and fast filter exchange – without tools
  - Identical filters for EASY ARM 1 and EASY ARM 2
  - Interface to interact with i-CON soldering stations

Ersa solder fume extraction units are based on over 15 years of experience in process air cleaning by Ersa.

They stand out by a high suction power and an efficient filter performance combined with super silent operation. Exhaust volume per arm is 110 m<sup>3</sup>/h. Both the **EASY ARM 1** and **EASY ARM 2** are equipped with filters that clean the process air in three stages: The pre-filter absorbs dust and big particles. The combined filter separates micro particles which occur during soldering and absorbs dangerous gas molecules in the incorporated activated carbon filter.

The operator can choose between a system with one exhaust arm – the EASY ARM 1 – and a unit with two exhaust arms – the EASY ARM 2. Both units can be mounted individually by means of their table clamp. Exhaust power is set independently for each extraction arm at the touch of a button. The EASY ARM 1 and EASY ARM 2 use an identical pre-filter and combined filter. Optical and acoustical signals inform the

operator when filters have to be exchanged. A wide range of exhaust arms and nozzles for all applications are available so that the user will find the proper solution for his requirements.

For energy saving purposes and to extend filter lifetime, both units can be connected with Ersa i-CON soldering stations or a standby switch. In this way, the extraction unit is only working whilst the attached soldering station is in operation, stopping as soon as the soldering station goes into standby mode.



*Ersa EASY ARM 1 with exhaust arm Omniflex and round exhaust nozzle*

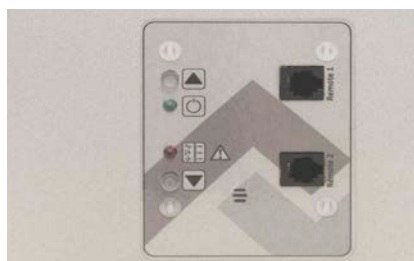

*Clearly structured control panel*



*High-end filter materials, same filters for EASY ARM 1 and EASY ARM 2*

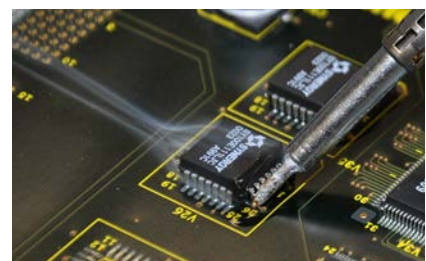

*Efficient solder fume extraction directly at the solder joint*

# Ersa EA 1 and EA 2 solder fume extractions



CE



Order no.	Description	Dimensions (L x W x H)	Rating/voltage	Volume flow/ vacuum	Noise level	Filter
OCA10-001	Filter unit Ersa EASY ARM 1, complete, with i-CON C interface	255 x 255 x 470 mm	40 W / 100 – 240 V 50 – 60 Hz	130 m³/h max. / 1,800 Pa	max. 50 dB (A)	HEPA activated carbon
OCA10-002	Filter unit Ersa EASY ARM 2, complete, with i-CON C interface	490 x 255 x 470 mm	80 W / 100 – 240 V 50 – 60 Hz	2 x 130 m³/h max. / 2 x 1,800 Pa	max. 50 dB (A)	HEPA activated carbon

## EA 1 and EA 2 accessories

### OCA10-4002

Extraction arm Highflex, 1,000 mm, direct mount at the filter unit



### OCA10-4003

Extraction arm Omniflex, 900 mm, direct mount at the filter unit



### OCA10-4001

Hinged extraction arm, 500 mm, Highflex, table mount, incl. OCA10-2002



### OCA10-4004

Hinged extraction arm, 600 mm, Omniflex, table mount, incl. OCA10-2002



### OCA10-2002

Connecting hose, 2,000 mm



### OCA10-9006

Nozzle coupling Omniflex (only with extraction arms Omniflex and extraction nozzles 5001/5004)



### OCA10-5001\*

Extraction nozzle, metallic, antistatic, 60 mm ø



### OCA10-5002

Extraction nozzle, round, ø 118 mm, antistatic



### OCA10-5003

Extraction nozzle, rectangular, 155 mm x 90 mm, antistatic



### OCA10-5004\*

Extraction nozzle Plus, 230 mm x 85 mm, transparent



### OCA10-5005\*

Extraction nozzle, plastic antistatic, 60 mm ø



### 3CA10-9001

Table clamp for EASY ARM 1



### 3CA10-9002

Table clamp for EASY ARM 2



### 3CA10-1001

Combined filter, particle filter H13, gas filter activated carbon



### OCA10-1002/04

Prefilter, particle filter F7 (4 pcs./packing unit)



### 3CA10-2003

Interface cable to connect soldering stations with interfaces



### 3CA10-2004

Standby switch



### 3CA10-9004

Appliance coupling



### 3CA10-9008

Cover lid vor EA 2



### OCA10-4005

Table duct Omniflex incl. OCA10-2002



### 291405

Table duct with extraction arm Omniflex, 600 mm, incl. OCA10-2002



### 290763

Table duct with extraction arm Highflex, 500 mm, incl. OCA10-2002



\* In combination with an Omniflex arm, nozzle coupling Omniflex OCA10-9006 is required.

# Accessories and process materials

All about soldering – supplied from one source: Ersa special devices and tools, temperature measurement devices, auxiliaries and consumables for the production and repair of high-quality boards.



## Ersa IRHP 200 infrared heating plate



The Ersa **IRHP 200** is a compact and ergonomically designed heating plate to preheat all SMD components as well as assemblies and substrates during the hand soldering process. It can also be used to reflow solder one-sided SMD boards and for reballing BGAs.

The IR emitters' even heat distribution ensures non-contact, gentle heating of the assembly. Thus the IRHP 200 is perfectly suited for lead-free applications.

The control station can be placed independently from the heating plate on the workbench in an ergonomically favorable way.



### Ersa IRHP 200

Electronically temperature-controlled infrared rework heating plate with integrated thermocouple, incl. control station ORA4500D

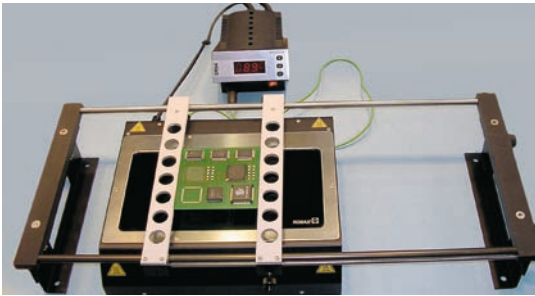

Application example with optionally available X/Y PCB table OIR5500-01

Order no.	Description	Heated area (L x W)	Dimensions (L x W x H)	Rating/voltage	Weight
OIRHP200	IRHP 200 infrared rework heating plate with control station ORA4500D	260 x 135 mm	300 x 250 x 90 mm	max. 800 W / 230 V~, 50 – 60 Hz	approx. 4 kg
<b>1IRHP20000A67</b>	<b>with temperature regulator 1RA4500D00A67</b>			<b>115 V~, 50 – 60 Hz</b>	

## Ersa IRHP 100 A infrared heating plate



The **IRHP 100 A** infrared heating plate offers bottom-side PCB preheating for hand soldering, desoldering and touch-up applications. The safe and powerful medium wavelength IR heating technology offers a tremendous benefit to today's workbench. Working temperatures of the soldering tools can be greatly reduced. Lower tip temperatures decrease the risk of PCB damage while at the same time greatly increasing tip lifetime. The heating plate is controlled by either the i-CON1 C or the i-CON2 C.



### Ersa IRHP 100 A

Infrared rework heating plate, controlled in 6 stages via the optional i-CON1 C control station

Order no.	Description	Heated area (L x W)	Dimensions (L x W x H)	Rating/voltage	Weight
OIRHP100A-03	IRHP 100 A infrared rework heating plate	125 x 125 mm	200 x 260 x 53,5 mm	250 W (stage 6) 230 V~, 50 – 60 Hz	approx. 2.6 kg
<b>OIRHP100A-04</b>				<b>115 V~, 50 – 60 Hz</b>	

## Ersa special tools



The **ERSA 185 PZ** plastics welding device can be used to cut, weld and seal thermoplastic foil, fabric and sealing sections. In cutting plastic cords, the ERSA 185 PZ simultaneously welds the ends, to prevent untwisting.



### Ersa 185 PZ

Plastics welding device

Order no.	Description	Rating/voltage	Heating time	Temperature range	Weight (w/o cable)
O185PZ	ERSA 185 PZ plastics welding device with welding blade O182PZ004	150 W/230 V	approx. 5 min	approx. 370 °C	370 g
<b>1185PZA068</b>		<b>150 W/115 V</b>			

# Ersa DTM 100 temperature measuring device



In certified businesses and from a quality standpoint, regular checks of the soldering tip temperature are obligatory. Viewed through their entire service life, Ersa soldering stations are extremely temperature-stable depending on the system.

Possible differences between the set and actual value due to differences in tips or to slight heating element tolerances in the RESISTRONIC control system can be easily ascertained with the **DTM 100** temperature measuring device and corrected easily and fast on nearly all Ersa soldering stations.

The measurement is conducted by cleaning the heated soldering tip with a moist sponge and wetting it with new solder. The soldering tip is then put on the sensor wires. As soon as the display has stabilized the temperature is determined.

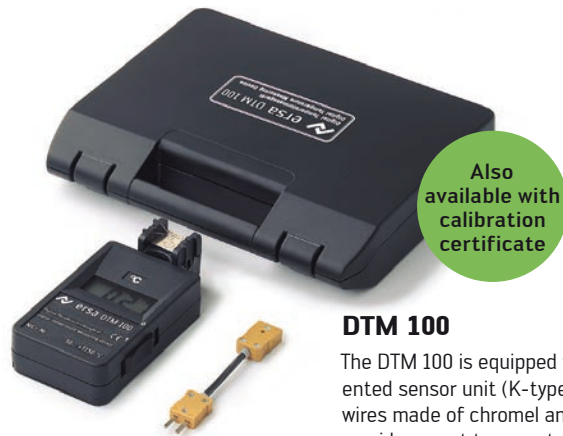

Also available with calibration certificate

## DTM 100

The DTM 100 is equipped with a patented sensor unit (K-type) with sensor wires made of chromel and alumel. It provides exact temperatures of even finest soldering tips.

Order no.	Description	Measuring range	Operating temperature	Power supply	Dimensions (mm) without sensor unit	Weight
0DTM100	DTM 100 temperature measuring device, packed in a plastic case	-50 °C bis +1,150 °C	0 °C bis +45 °C	9 V flat battery 6F22	100 x 60 x 26 mm	approx. 134 g
0DTM100P	DTM 100 temperature measuring device with calibration certificate, packed in a plastic case	-50 °C bis +1,150 °C	0 °C bis +45 °C	9 V flat battery 6F22	100 x 60 x 26 mm	approx. 134 g

# Ersa SVP 100 vacuum pipette



The **SVP 100** vacuum pipette can be used to handle nearly all components, except MELFs and MiniMELFs. This tool consists of a nickel-plated aluminum handle, sealed at the rear end by a plug. When opened, replacement tips and suction cups can be stored here.



## SVP 100

Vacuum pipette

Order no.	Description	Length	Housing diameter	Cup diameters	Weight
0SVP100	SVP 100 vacuum pipette, complete, with bent tip 0SVP12K and 3 silicone cups 0SVP13A	150 mm	14 mm	4 mm, 6 mm, 9 mm	69 g

# Ersa desoldering devices



The **VAC X** desoldering device is distinguished by its high suction power and low-recoil desoldering. The antistatic design allows desoldering work on electrostatically endangered assemblies. Due to the long and slim desoldering tips the VAC X can also be used on densely populated PCBs.

The **SOLDAPULLT AS 196** model is distinguished by extremely good recoil damping and has proven its merit many times over in industry. The dual seal ring system guarantees constant suction power on a high level.



## VAC X

Antistatic desoldering device with plastic housing

## SOLDAPULLT AS 196

Proven desoldering device with plastic housing and excellent recoil damping



Order no.	Description	Desoldering tips	Suction capacity
0VACX	VAC X antistatic desoldering device	0VACX2 (2 pcs.)	11,3 cm³
0AS196	SOLDAPULLT AS 196 antistatic desoldering device	0LS197	34 cm³

## Ersa Stapel-Rack STR 100 und STR 200



The Ersa **STR 100** stacking rack can be used for combining two soldering stations, e.g. the DIG 2000 A electronic station with the vacuum unit as required (see adjacent illustration) in a practical and space-saving way.

The Ersa **STR 200** stacking rack can be used for combining two i-CON soldering stations or one i-CON station with any other Ersa soldering station.

### STR 100/STR 200

Stacking racks for a well-organized workplace (Delivery without soldering stations)

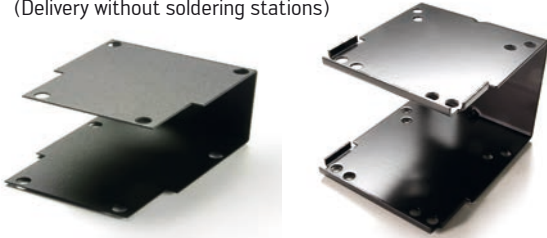

Order no.	Description
OSTR100	STR 100 stacking rack to arrange soldering stations (except i-CON) in a safe and space-saving way on the workbench
OSTR200	STR 200 stacking rack to arrange the Ersa i-CON soldering stations in a safe and space-saving way on the workbench

## Ersa SR 100 solder wire dispenser

The Ersa **SR 100** solder wire dispenser is extremely durable and can accept solder wire reels of up to 1,000 g.

Optimal unwinding of different reels is ensured by a conical centering nut.

The flexibly mounted solder wire guide is suitable for all current solder wire diameters and allows unwinding in the desired direction without having to change the location of the SR 100.

Available as an accessory and easily retrofitted, the Ersa **SR 101** kit allows simultaneous use of a second spool.

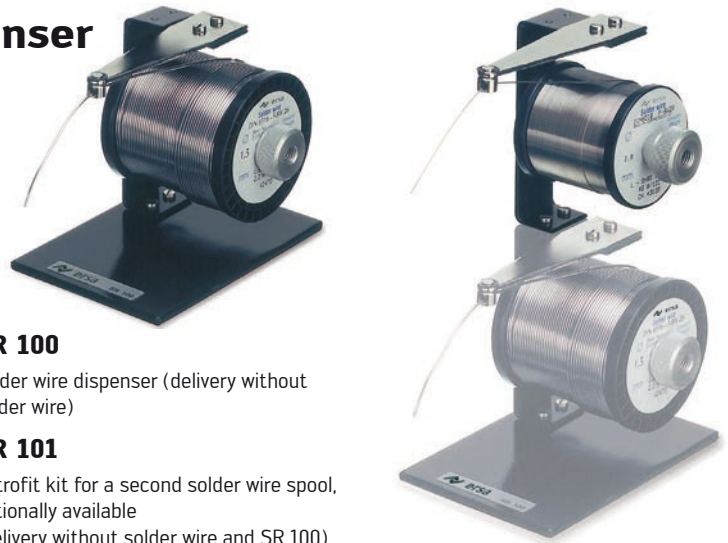

### SR 100

Solder wire dispenser (delivery without solder wire)

### SR 101

Retrofit kit for a second solder wire spool, optionally available (Delivery without solder wire and SR 100)

Order no.	Description	Solder wire spools	Spool receiver diameter
OSR100	SR 100 solder wire dispenser for one spool	250 g, 500 g, 1,000 g	14 mm
OSR101	Retrofit kit SR 101 for a 2nd spool	250 g, 500 g, 1,000 g	14 mm

## Ersa tip exchanger



For changing all internally heated soldering and desoldering tips as well as hot-air nozzles, we recommend tip exchanger 3ZT00164 with flat nose pliers and side cutter. These special pliers allow tips to be replaced safely and protectively, even when hot.



### 3ZT00164

Tip exchanger with flat nose pliers and side cutter

Order no.	Description	Application
3ZT00164	Tip exchanger	For changing all internally heated Ersa soldering tips and desoldering tips of the 422/452 desoldering tip series and 802 hot-air nozzles



# Ersa tool holders and cleaning sponges

**0A04**



**0A05**



**0A08MSET**



**0008M**



Soldering and desoldering devices are heating devices and, depending on the application, can attain high temperatures during operation. This equipment must never be operated without supervision; during longer interruptions of work they should be switched off and always be stored in suitable tool holders.

Most of the Ersa tool holders are made of metal or heat-resistant duro-plastic, and most are antistatic.

Most holders have a viscous sponge for tip cleaning, as well as options for conveniently resting and storing soldering and desoldering tips.

**0A17**



**0A18**



**0A42**

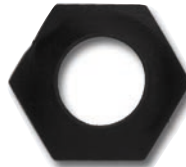

**0A45**

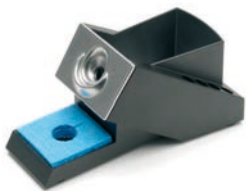

**0A52**



**3N194**



**0A53**



**0A54**



**0A55**



**0A56**



**0A57**



**0003B**

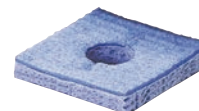

**0004G**



Order no.	Description	for
0A04	Tool holder A 04	Soldering irons from 50 W – 150 W output; ISOTYP and 0185PZ soldering irons
0A05	Tool holder A 05	Medium-sized and small soldering irons
0A08MSET	Dry sponge 0008M with container	Dry cleaning of soldering tips (especially for lead-free)
0A17	Tool holder A 17	Soldering irons with an output ranging from 200 W – 550 W
0A18	Tool holder A 18	Soldering irons of the MULTITIP series; TIP 260 soldering iron
0A39	Tool holder A39	RT 80 soldering iron (fig. see page 13)
0A42	Tool holder A 42, antistatic	TIP TOOL, POWER TOOL, ERGO TOOL, MICRO TOOL and TECH TOOL soldering irons
0A43	Tool holder A 43, antistatic	CHIP TOOL (fig. see page 22)
0A44	Tool holder A 44, antistatic	X-TOOL desoldering iron
0A45	Universal holder A 45	832 tip series (C8 – C18, MD, QD, ZD models), solder wire feed unit and solder fume extraction
0A52	Tool holder A 52, antistatic	i-TOOL, i-TOOL NANO soldering irons
0A53	Tool holder A 53	i-TOOL PICO soldering iron
0A54	Tool holder A 54, antistatic	CHIP TOOL VARIO desoldering tweezers
0A55	Tool holder A 55, antistatic	i-TOOL AIR S hot-air iron
0A56	Tool holder A 56, antistatic	X-TOOL VARIO desoldering iron
0A57	Tool holder A 57, antistatic	i-TOOL HP soldering iron
3N194	Rubber support disk 3 N 194	MULTITIP, MULTI-PRO, Ersa 30 S soldering irons
05H03	SMD soldering and desoldering tip holder	Soldering and desoldering tips of the 212, 422 and 452 series
06156	Sponge container G156	INDEPENDENT 75 and INDEPENDENT 130 gas soldering irons
0003B	Blue viscose sponge, 55 x 55 mm	Tool holders 0A09, 10, 13, 16, 24, 25, 28, 29, 30, 34, 35, 36, 39, 41 – 45, 48
0004G	Viscose sponge, 34 x 65 mm	Tool holders 0A05, 0A21 and 0A26
0006G	Sponge, ø 36 mm	Sponge container 06156 for the INDEPENDENT 75 / 130 gas soldering irons
0008M	Dry sponge 0008M	Dry sponge holder 0A08MSET

## Ersa bar solder



Ersa **bar solder**, like solder wire, is recovered from initial melt solder. It is primarily used for filling solder baths. For easier melting, it can be supplied as required in 50 mm sections. In combination with soldering irons of greater power and with suitable flux, bar solder is also used for soldering cable lugs of larger cross-sections and in sheet metal work.



### Bar solder

High-quality bar solder recovered from initial melt solder to refill solder baths.

Order no.	Alloy	Melting temperature	Delivered in
4LOT230GAG3.5CU0.7	Sn95,8Ag3,5Cu0,7	217 – 218 °C	Bars of approx. 230 g
4LOT230G64B	Sn64Pb36	183 °C	Bars of approx. 230 g

## Ersa solder wire

Ersa solder wire consists exclusively of high-quality raw materials. Manufactured on state-of-the-art machines, the wire meets all quality requirements. It is manufactured in different dimensions and with different alloys, to meet all practical requirements. Different types of "flux cores" allow individual adaptation to all soldering needs, especially in electronics and the electronic industry.

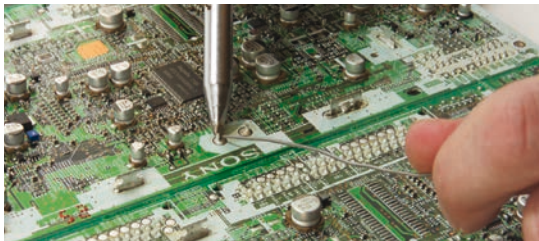

### Solder wire

Available in different alloys and drum sizes in order to meet various fields of application. Please refer to the Ersa price list or to [www.ersa.com](http://www.ersa.com) for a detailed list including wire diameters.



Solder alloy according to DIN EN 29453	Flux according to DIN EN ... % flux share	Melting temperature (°C)
Sn96,5Ag3,0Cu0,5	29453, J-STD-004A/EN61190-1-1: ROL0, halogen-free, 3.5%	217
Sn96,5Ag3,0Cu0,5	29453, J-STD-004A/EN61190-1-1: RELO, halogen-free, 1.6%	217 – 219
Low-residue, halogen-free No-Clean solder wire. Especially adapted to the requirements in electronic production. The flux stands out by high temperature resistance, and it does not spray while melting. The light, solid flux residues are neither corrosive nor electrically conductive. Consequently it is not necessary to remove them from the solder joint.		
Sn60Pb40	29453, J-STD-004A/EN61190-1-1: ROM1, 2.2%	183 – 190
Sn60Pb40	29453, J-STD-004A/ EN61190-1-1: RELO, 1.4%	183 – 190
Sn63Pb37	29453, J-STD-004A/EN61190-1-1: ROL0, halogen-free, 0.9%	183

subject to changes

## Ersa desoldering wicks

Ersa **desoldering wicks** are saturated with halogen-free No-Clean flux. They are suitable for protectively removing excess solder and old solder, especially from boards carrying SMD components. A fine copper fabric with high capillary power ensures optimal desoldering results. The additional use of a flux cream may be appropriate under certain circumstances.

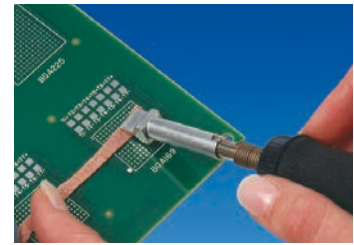

Order no.	Description	Package size
0WICKNC1.5/10	No-Clean wicks, length 1.5 m, width 1.5 mm	10 pcs.
0WICKNC1.5/SB	No-Clean wicks, length 1.5 m, width 1.5 mm	single-piece package
0WICKNC2.2/10	No-Clean wicks, length 1.5 m, width 2.2 mm	10 pcs.
0WICKNC2.2/SB	No-Clean wicks, length 1.5 m, width 2.2 mm	single-piece package
0WICKNC2.7/10	No-Clean wicks, length 1.5 m, width 2.7 mm	10 pcs.
0WICKNC2.7/SB	No-Clean wicks, length 1.5 m, width 2.7 mm	single-piece package
0WICKNC4.9/10	No-Clean wicks, length 1.5 m, width 4.9 mm	10 pcs.
0WICKNC4.9/SB	No-Clean wicks, length 1.5 m, width 4.9 mm	single-piece package

## Ersa flux and flux removers

Ersa **No-Clean flux** and **flux cream** have proven their merit especially in all repair processes in SMD technology. Like all Ersa consumables, they meet the applicable standards and quality requirements. They can easily and precisely be applied by means of the FLUX-PEN or cartridge, supplied with plunger and needle.

Excess residue is removed, if necessary, by means of the **FLUX REMOVER** with the aid of absorbent, non-pulping paper towels or specially offered ESD-safe products.



**Flux Cream**

Ersa No-Clean flux creams available in different quantities



**FLUX-REMOVER**



**FLUX-PEN**

Order no.	Description	Quantities	Danger sign
0FMKANC32-005	No-Clean flux cream, EN 29454/1.1.3 C	5 ml cartridge	05); 07)
0FMKANC32-200	No-Clean flux cream, EN 29454/1.1.3 C	200 ml can	05); 07)
4FMJF8300-005	Flux gel 8300 for rework, EN 29454-1/1.2.3 C (F-SW33), resinous, halogen-free, low residues	5 ml cartridge	07)
4FMJF8300-030	Flux gel 8300 for rework, EN 29454-1/1.2.3 C (F-SW33), resinous, halogen-free, low residues	30 ml cartridge	07)
0FMJF8001-PEN	FLUX-PEN with IF 8001 flux, EN 29454/2.2.3 A (F-SW 34/DIN 8511)	7 ml	02); 08)
0FMIF8001-001	IF 8001 flux, EN 29454/2.2.3 A	100 ml	02); 08)
4FMJF6000-PEN	FLUX-PEN with IF 6000 flux, for lead-free rework, EN 29454/1.1.3 A, solid 7.5 %	7 ml	02); 07)
0FMIF6000-001	IF 6000 Flux for lead-free rework, EN 29454/1.1.3 A (F-SW 32), resinous, halogen-free, long activation time, low residues, solid 7.5 %	100 ml	02); 07)
0FMIF2005-002	IF 2005 M low-solid No-Clean flux EN 29454/2.2.3 A	200 ml sprayer	02); 07); 08)
0FR400	FLUX REMOVER 0FR400, with brush 0FR202 and protective cap 0FR203	400 ml cartridge	02); 07); 09)

## Ersa TIP-REACTIVATOR

The Ersa **TIP-REACTIVATOR** allows the regeneration of oxidized soldering tips. It is environmentally safe, free of lead and halogens and functions even at low soldering tip temperatures. For this purpose the heated soldering tip is wiped on the surface of the regeneration compound.



Order no.	Description	Quantity	Danger sign
0TR01/SB	TIP-REACTIVATOR, lead-free	15 g can	07)
0TR02/SB	TIP-REACTIVATOR, lead-free, minimal residues	30 g can	07)



# Soldering and desoldering tips

The soldering tip is the “heart” of the soldering iron. Its job is to transfer the heat from the heating element via the solder to the solder joint. Depending on the soldering iron and the application, different types of tips are available. Prerequisites for good solder joints are a correct tip shape, perfect heat transfer, an excellent condition of the tip and a reliable stability. In addition, the soldering tip also has to convey the necessary amount of sensitivity back to the operator.

ERSADUR long-life tips are designed for continuous operation and for high-quality results. They are galvanically plated with an iron coating and protected against corrosion and oxidation by an additional chrome layer. This manufacturing process was developed and is used exclusively by Ersal. The ERSADUR tips' perfect thermal conductivity protects the heating element from overheating and premature wear. Ersal offers a comprehensive range of soldering tips for the diverse requirements.

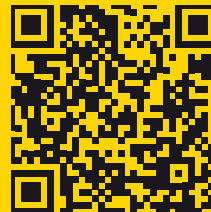

Youtube:  
Ersal explains #1 -  
Soldering tip care



# ERSADUR soldering tips



Cross-section of an ERSADUR tip, non-scale representation

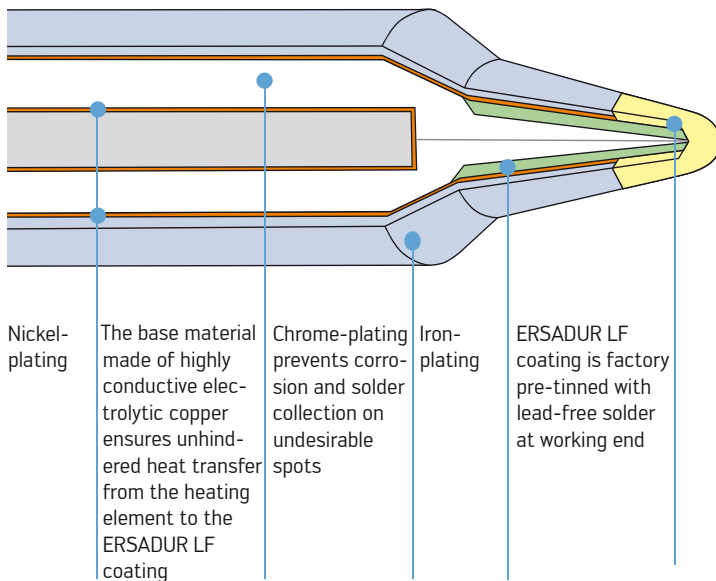

## Special care for soldering tips

### Important facts:

1. When a soldering tip remains hot for a long period of time, the tip will oxidize or blacken. An oxidized tip will no longer "wet" or melt solder properly.
2. The higher the **working temperature** of the soldering tip, the faster this oxidation will take place and tip lifetime will be shorter.
3. Soldering irons that automatically go into a lower "standby" temperature increase tip life.
4. **The oxidation of the tip will be very rapid** if the tip is left "cooking" without molten solder covering the tip end. It happens, for example, if the tip is not wetted with solder right after cleaning it.
5. Excessive **mechanical force** during soldering will shorten the tip life.
6. Proper care of the tip will greatly **increase tip life**.
7. **Lead-free soldering** requires **higher temperatures**, is more aggressive to the tip and will always lead to shorter tip life.

### Special care:

1. Always clean the tip by wiping on a slightly wet sponge after each use. Alternatively, tips can be dry cleaned using the Ersa dry sponge.
2. Always put fresh solder onto the end of the tip **BEFORE** putting the tip back into the tool holder.
3. Always use lowest working temperature possible.
4. Never leave an iron "cooking" unattended for some time. Always set iron into automatic standby if possible or turn off when not in use.
5. Never use excessive mechanical force when soldering.
6. Soldering tip oxidation can be easily removed if detected early. Early detection and removal will greatly increase tip life.
7. Tip oxidation removal or tip refurbishing is accomplished in 4 consecutive steps:
  - Clean on damp sponge,
  - Clean with wire brush,
  - Use of a tip reactivator chemical
  - Retinning using proper flux cored solder wire.

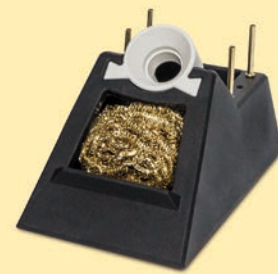

### Ersa Dry Sponge

The Ersa Dry Sponge (order no. 0008M) is an alternative to the wet sponge and can be beneficial, especially in lead-free soldering.

**Youtube:**  
Ersa explains  
#2 - X-TOOL  
VARIO



### Service Tool X-TOOL VARIO

Service tool for tip exchange and cleaning of the X-TOOL VARIO desoldering iron (order no. E074600).



### Cleaning kit for tip series 742 (X-TOOL VARIO)

The cleaning kit includes the fitting drill bits for the tips of the 742 series to remove residues in the suction channel of the tip (order no. E074700).



### Cleaning brush

Brush with brass bristles for gentle tip cleaning (order no. 3ZT00051). It can also be used to clean heating elements.

In the field of hand soldering a long tip lifetime with continuously good soldering results is essential for the users. Oxidized soldering tips can only slowly melt the solder, which decreases productivity. A soldering tip needs care in order to ensure an efficient process.

Dry cleaning of soldering tips offers substantial advantages. The soldering tips are not cooled abruptly and contaminated tips resulting from dirty sponges are avoided. Due to the slightly abrasive properties of the special wire mesh, passive layers that accumulated on the tip can easily be removed. Tip life is thus increased considerably in lead-free hand soldering.

## ERSADUR long-life soldering tip series 102



■ All i-CON soldering stations with soldering irons i-TOOL, i-TOOL NANO, i-TOOL PICO

<p><b>0102PDLF02</b></p> <p>pencil point, 0.2 mm <math>\varnothing</math></p>	<p><b>0102PDLF03L</b></p> <p>pencil point, extended, 0.3 mm <math>\varnothing</math></p>	<p><b>0102PDLF04</b></p> <p>pencil point, 0.4 mm <math>\varnothing</math></p>	<p><b>0102PDLF04L</b></p> <p>pencil point, extended, 0.4 mm <math>\varnothing</math></p>
<p><b>0102PDLF05L</b></p> <p>pencil point, extended, 0.5 mm <math>\varnothing</math></p>	<p><b>0102PDLF06</b></p> <p>pencil point, 0.6 mm <math>\varnothing</math></p>	<p><b>0102PDLF06L</b></p> <p>pencil point, extended, 0.6 mm <math>\varnothing</math></p>	<p><b>0102PDLF07</b></p> <p>pencil point, 0.7 mm <math>\varnothing</math></p>
<p><b>0102PDLF08L</b></p> <p>pencil point, extended, 0.8 mm <math>\varnothing</math></p>	<p><b>0102PDLF10</b></p> <p>pencil point, 1.0 mm <math>\varnothing</math></p>	<p><b>0102CDLF04</b></p> <p>chisel-shaped, 0.4 mm</p>	<p><b>0102CDLF12</b></p> <p>chisel-shaped, 1.2 mm</p>
<p><b>0102CDLF16</b></p> <p>chisel-shaped, 1.6 mm</p>	<p><b>0102CDLF18L</b></p> <p>chisel-shaped, extended, 1.8 mm</p>	<p><b>0102CDLF20</b></p> <p>chisel-shaped, 2.0 mm</p>	<p><b>0102CDLF24</b></p> <p>chisel-shaped, 2.4 mm</p>
<p><b>0102CDLF24L</b></p> <p>chisel-shaped, extended, 2.4 mm</p>	<p><b>0102CDLF32</b></p> <p>chisel-shaped, 3.2 mm</p>	<p><b>0102CDLF50</b></p> <p>chisel-shaped, 5.0 mm</p>	<p><b>0102CDLF65</b></p> <p>chisel-shaped, 5.0 mm</p>
<p><b>0102CDLF080C</b></p> <p>chisel-shaped, conical, 8.0 mm</p>	<p><b>0102CDLF100</b></p> <p>chisel-shaped, 10.0 mm</p>	<p><b>0102CDLF100C</b></p> <p>chisel-shaped, conical, 10.0 mm</p>	<p><b>0102CDLF120C</b></p> <p>chisel-shaped, conical, 12.0 mm</p>

Dimensions without pre-tinning

# ERSADUR long-life soldering tip series 102



■ All i-CON soldering stations with soldering irons i-TOOL, i-TOOL NANO, i-TOOL PICO

<p><b>0102CDLF200</b></p> <p>angled face, 20.0 mm</p>	<p><b>0102SDLF04</b></p> <p>pencil point, bent, 0.4 mm ø</p>	<p><b>0102SDLF06</b></p> <p>pencil point, bent, 0.6 mm</p>	<p><b>0102SDLF06L</b></p> <p>pencil point, bent, extended, 0.6 mm ø</p>
<p><b>0102SDF08L</b></p> <p>pencil point, bent, extended, 0.8 mm ø</p>	<p><b>0102SDF18</b></p> <p>chisel-shaped, bent, 1.8 mm ø</p>	<p><b>0102ADLF13</b></p> <p>angled face, 1.3 mm ø</p>	<p><b>0102ADLF15</b></p> <p>angled face, 1.5 mm ø</p>
<p><b>0102ADLF20</b></p> <p>angled face, 2.0 mm ø</p>	<p><b>0102ADLF40</b></p> <p>angled face, 4.0 mm ø</p>	<p><b>0102ZDLF100</b></p> <p>Wick-Tip, 10.0 mm</p>	<p><b>0102ZDLF150</b></p> <p>Wick-Tip, 15.0 mm</p>
<p><b>0102ZDLF200</b></p> <p>Wick-Tip, 20.0 mm</p>	<p><b>0102ZDLF370</b></p> <p>Wick-Tip, 37.0 mm</p>	<p><b>0102BDLF20</b></p> <p>PLCC blade</p>	<p><b>0102PDLF03</b></p> <p>soldering tip, lead-free, 0.3 mm</p>
<p><b>0102WDLF16</b></p> <p>PowerWell with concave portion, 1.6 mm ø</p>	<p><b>0102WDLF23</b></p> <p>PowerWell with concave portion, 2.3 mm ø</p>	<p><b>0102WDLF35</b></p> <p>PowerWell with concave portion, 3.5 mm ø</p>	<p><b>0102CDLF24A</b></p> <p>asymmetrical, 2.4 mm, 300µm Fe</p>
<p><b>0102CDLF46A</b></p> <p>asymmetrical, 4.6 mm, 300µm Fe</p>	<p><b>0102CDLF80A</b></p> <p>chisel-shaped, asymmetrical, 8.0 mm</p>		

# ERSADUR long-life soldering tip series 832, 842 and 852



- ANALOG 60/60 A
- ANALOG 80/80 A
- DIGITAL 80 A
- DIGITAL 2000 A with POWER TOOL soldering iron
- ELS 8000/M/D

- ERSA 15+ / 25+ / 35+
- MICRO-CON 60 iA with POWER TOOL soldering iron
- MS 6000 / MS 8000/D
- MULTI-PRO
- MULTI-SPRINT

- MULTI-TC
- RDS 80
- TWIN 80 A with ERGO TOOL

<b>0832UD/UDLF</b>  pencil point, 0.4 mm $\varnothing$ , extended	<b>0832SD/SDLF</b>  pencil point, 0.8 mm $\varnothing$ , extended	<b>0832BD/BDLF</b>  pencil point, 1.0 mm $\varnothing$	<b>0832YD/YDLF</b>  chisel-shaped, 1.6 mm
<b>0832CD/CDLF</b>  chisel-shaped, 2.2 mm	<b>0832KD/KDLF</b>  chisel-shaped, 2.2 mm, extended	<b>0832ED/EDLF</b>  chisel-shaped, 3.2 mm	<b>0832VD/VDLF</b>  chisel-shaped, 5.0 mm
<b>0832FDLF</b>  angled face, 2.0 mm	<b>0832TDLF</b>  angled face, 3.0 mm $\varnothing$	<b>0832NDLF</b>  angled face, 4.0 mm $\varnothing$	<b>0832PW</b>  PowerWell with concave portion
<b>0832HD</b>  SolderWell with concave portion, bent	<b>0832AD</b>  PLCC blade, 1.5 mm	<b>0852OD</b>  PLCC blade, 2.0 mm	<b>0832WD</b>  chisel-shaped, 2.5 mm, bent
<b>0832RD</b>  chisel-shaped, 5.0 mm, bent	<b>0832GDLF</b>  angled face, 14 mm, 35°	<b>0832LDLF</b>  angled face, 17 mm, 35°	<b>0832MDLF</b>  angled face on both sides, 8 mm
<b>0842UD/UDLF</b>  pencil point, 0.4 mm $\varnothing$ , extended	<b>0842SD/SDLF</b>  pencil point, 0.8 mm $\varnothing$ , extended	<b>0842BD/BDLF</b>  pencil point, 1.0 mm $\varnothing$	<b>0842YD/YDLF</b>  chisel-shaped, 1.6 mm
<b>0842CD/CDLF</b>  chisel-shaped, 2.2 mm	<b>0842KD/KDLF</b>  chisel-shaped, 2.2 mm, extended	<b>0842ED/EDLF</b>  chisel-shaped, 3.2 mm	<b>0842ID</b>  pencil point, 0.4 mm $\varnothing$ , bent
<b>0842JD</b>  chisel-shaped, 2.2 mm, bent	<b>0852GD</b>  angled face, 8.0 mm	<b>0852VD</b>  chisel-shaped, 5.0 mm	

Dimensions without pre-tinning



# ERSADUR long-life soldering tip series 612



- CPS 60.10
- DIGITAL 60 A
- DIGITAL 2000 A with TECH TOOL soldering iron
- MICRO-CON 60 iA with TECH TOOL soldering iron

<p><b>0612SDF</b></p> <p>pencil point, 0.4 mm <math>\phi</math></p>	<p><b>0612UDLF</b></p> <p>pencil point, 0.8 mm <math>\phi</math></p>	<p><b>0612BDF</b></p> <p>pencil point, 1.0 mm <math>\phi</math></p>	<p><b>0612CDF</b></p> <p>chisel-shaped, 1.0 mm</p>
<p><b>0612ADLF</b></p> <p>chisel-shaped, 1.6 mm</p>	<p><b>0612KDLF</b></p> <p>chisel-shaped, 2.4 mm</p>	<p><b>0612EDLF</b></p> <p>chisel-shaped, 3.2 mm <math>\phi</math></p>	<p><b>0612JD</b></p> <p>chisel-shaped, 1.6 mm, bent 30°</p>
<p><b>0612ID</b></p> <p>pencil point, 0.4 mm <math>\phi</math>, bent 30°</p>	<p><b>0612MD</b></p> <p>PLCC blade, 1.5 mm</p>	<p><b>0612TW</b></p> <p>Ersa TechWell with concave portion, 3.0 mm</p>	<p><b>0612HD</b></p> <p>Ersa SolderWell with concave portion 2.5 mm, 30° bent</p>
<p><b>0612ZD</b></p> <p>WickTip, 10.5 x 3.6 mm</p>	<p><b>0612ND</b></p> <p>angled face, 3.0 mm, 45°</p>	<p><b>0612FDLF</b></p> <p>angled face, 2.0 mm, 45°</p>	<p><b>0612WDLF</b></p> <p>angled face, 4.0 mm, 45°</p>

# ERSADUR long-life soldering tip series 242



- i-CON VARIO 2 & 4 with i-TOOL HP soldering iron

<p><b>0242CDF50</b></p> <p>chisel-shaped, 5 mm</p>	<p><b>0242SDF90</b></p> <p>chisel-shaped, 9 mm, bent 40°</p>	<p><b>0242CDF100</b></p> <p>chisel-shaped, 10 mm</p>	<p><b>0242CDF120</b></p> <p>chisel-shaped, 12 mm</p>
<p><b>0242CDF200</b></p> <p>chisel-shaped, 20 mm</p>	<p><b>0242CDF109A</b></p> <p>chisel-shaped, asymmetric, 10.9 mm</p>		

# ERSADUR long-life soldering tip series 212



- ANALOG 20 A
- DIGITAL 2000 A with MICRO TOOL soldering iron
- MICRO-CON 60 iA with MICRO TOOL soldering iron
- REWORK 80
- SMD 8000
- SMT UNIT 60 A/AS
- TWIN 40 A/AS
- TWIN 80 A with MICRO TOOL soldering iron

<p><b>0212SDLF</b></p> <p>pencil point, 0.2 mm <math>\varnothing</math></p>	<p><b>0212BDLF</b></p> <p>pencil point, 0.4 mm <math>\varnothing</math></p>	<p><b>0212ADLF</b></p> <p>pencil point, 1.0 mm <math>\varnothing</math>, reinforced</p>	<p><b>0212CDLF</b></p> <p>chisel-shaped, 1.0 mm</p>
<p><b>0212EDLF</b></p> <p>chisel-shaped, 1.8 mm</p>	<p><b>0212KDLF</b></p> <p>chisel-shaped, 1.8 mm, extended</p>	<p><b>0212FDLF</b></p> <p>chisel-shaped, 2.2 mm, reinforced</p>	<p><b>0212GD</b></p> <p>chisel-shaped, 3.2 mm, reinforced</p>
<p><b>0212VD</b></p> <p>chisel-shaped, 5.0 mm, reinforced</p>	<p><b>0212RD</b></p> <p>pencil point, 0.2 mm <math>\varnothing</math>, bent</p>	<p><b>0212ID</b></p> <p>bent, 0.6 mm <math>\varnothing</math>, reinforced</p>	<p><b>0212ND</b></p> <p>angled face, 2.0 mm, reinforced</p>
<p><b>0212WD</b></p> <p>MiniMicroWell, 1.6 mm <math>\varnothing</math></p>	<p><b>0212MS</b></p> <p>MicroWell, 2.1 mm <math>\varnothing</math></p>	<p><b>0212OD</b></p> <p>SolderWell, 3.0 mm <math>\varnothing</math></p>	

# Pairs of desoldering tips, series 462



- i-CON1 V/2 V
  - i-CON VARIO 2
  - i-CON VARIO 4
- each with CHIP TOOL VARIO

<p><b>0462PDLF005</b></p> <p>pencil point, 0.5 mm <math>\varnothing</math></p>	<p><b>0462CDLF010</b></p> <p>chisel-shaped, 1 mm</p>	<p><b>0462CDLF018</b></p> <p>chisel-shaped, 1.8 mm</p>	<p><b>0462SDLF002</b></p> <p>pencil point, 0.2 mm <math>\varnothing</math>, bent</p>
<p><b>0462MDLF007</b></p> <p>chisel-shaped, 0.7 mm, bent</p>	<p><b>0462MDLF015</b></p> <p>chisel-shaped, 1.5 mm, bent</p>	<p><b>0462FDLF060</b></p> <p>desoldering tips, 6 mm</p>	

# ERSADUR pairs of desoldering tips, series 422/452



- DIGITAL 2000 A with CHIP TOOL
- MICRO-CON 60 iA with SMD DESOLDERING PINCETTE 40
- REWORK 80
- SMD 8000

- SMT UNIT 60 AC/A with CHIP TOOL/  
SMD DESOLDERING PINCETTE 40
- all i-CON stations with CHIP TOOL

<b>0452FDLF040</b>  4 mm, for e.g. SO 8 GT/14 GT/16GT	<b>0422ED</b>  6 mm, for e.g. SOIC 8	<b>0452EDLF060</b>  6 mm, for e.g. SOIC 8	<b>0452FDLF075</b>  7.5 mm, for e.g. SOIC 2/SOT 23
<b>0452FDLF100</b>  10 mm, for e.g. SOIC 16	<b>0452FDLF125</b>  12.5 mm, for e.g. SOIC 20	<b>0452FDLF150</b>  15 mm, for e.g. SOIC 24	<b>0452FDLF175</b>  17.5 mm, for e.g. SOIC 28
<b>0452FDLF200</b>  20 mm, for e.g. SOIC 32	<b>0452FDLF250</b>  25 mm, for e.g. SOIC 40	<b>0452FDLF275</b>  27.5 mm, for components of 27.5 mm side length	<b>0452FDLF400</b>  40 mm, for components of 40 mm side length
<b>0452QDLF100</b>  90°, length 10 mm, for e.g. PLCC 20	<b>0452QDLF125</b>  90°, length 12.5 mm, for e.g. PLCC 28	<b>0452QDLF150</b>  90°, length 15 mm, for e.g. QFP, TQFP and TTQFP 80T25	<b>0452QDLF175</b>  90°, length 17.5 mm, for e.g. PLCC 44
<b>0452QDLF200</b>  90°, length 20 mm, for e.g. PLCC 52	<b>0452QDLF250</b>  90°, length 25 mm, for e.g. PLCC 68	<b>0452RDLF150</b>  length 15 x 12.5 mm, for e.g. PLCC 32	<b>0452RDLF225</b>  length 22.5 x 16.5 mm, for e.g. QFP 100
<b>0422MD</b>  ellipse, for MELF and MINIMELF	<b>0452MDLF020</b>  ellipse, for MELF and MINIMELF	<b>0422SD</b>  for MICROMELF	<b>*Please note:</b> Tips 0422SD must be used in combination with the tip turn protection set to ensure good results.  Tip turn protection set for TC 40 desoldering tweezers and DESOL- DERING PINCETTE 40 on request.

# Hot-air nozzle series 472



- i-CON VARIO 2  
with i-TOOL AIR S hot-air iron

- i-CON VARIO 4  
with i-TOOL AIR S hot-air iron

<b>0472AR</b>  hot-air nozzle, 2 mm $\varnothing$	<b>0472BR</b>  hot-air nozzle, 4 mm $\varnothing$	<b>0472CR</b>  hot-air nozzle, 6 mm $\varnothing$	<b>0472DR</b>  hot-air nozzle, bent, 1.7 mm / 0.067 in $\varnothing$	<b>0472ER</b>  hot-air nozzle, bent, 3.5 mm / 0.138 in $\varnothing$
---	---	---	--	--

## ERSADUR long-life soldering tip series 172

MULTITIP 25



<p><b>0172BD</b></p> <p>ERSADUR, pencil point, 1.1 mm <math>\phi</math></p>	<p><b>0172KD</b></p> <p>ERSADUR, chisel-shaped, 3.1 mm</p>	<p><b>0172LD</b></p> <p>ERSADUR, angled face 45°, 4.1 mm</p>
---	--	--

## ERSADUR long-life soldering tip series 162

MULTITIP 15  
TIP 260



<p><b>0162BD</b></p> <p>ERSADUR, pencil point, 1.1 mm <math>\phi</math></p>	<p><b>0162KD</b></p> <p>ERSADUR, chisel-shaped, 2.6 mm</p>	<p><b>0162LD</b></p> <p>ERSADUR, angled face, 45°, 3.6 mm</p>
---	--	---

## ERSADUR long-life soldering tip series 132

MULTITIP 08



<p><b>0132BD</b></p> <p>ERSADUR, pencil point, 1.0 mm <math>\phi</math></p>	<p><b>0132KD</b></p> <p>ERSADUR, chisel-shaped, 1.6 mm</p>	<p><b>0132LD</b></p> <p>ERSADUR, angled face, 45° Winkel, 2.6 mm</p>
---	--	--

## Soldering tip series G 072 and G 132

- INDEPENDENT 75 gas soldering iron (series G 072)
- INDEPENDENT 130 gas soldering iron (series G 132)



<p><b>0G072CN/0G132CN</b></p> <p>chisel-shaped, 1.0 mm</p>	<p><b>0G072KN/0G132KN</b></p> <p>chisel-shaped, 2.4 mm</p>	<p><b>0G072AN/0G132AN</b></p> <p>chisel-shaped, 3.2 mm</p>
<p><b>0G072VN/0G132VN</b></p> <p>chisel-shaped, 4.8 mm</p>	<p><b>0G072BE/0G132BE</b></p> <p>flame nozzle</p>	<p><b>0G072HE/0G132HE</b></p> <p>hot gas nozzle</p>
<p><b>0G072RE/0G132RE</b></p> <p>deflector for hot gas nozzle 0G072HE / 0G132HE to shrink heat shrinkable sleeves</p>		<p><b>0G072MN/0G132MN</b></p> <p>hot blade</p>

## ERSADUR long-life soldering tip series 042 and 012

- MINOR S (tips 042)
- MINITYP S (tip 0012BD)



<p><b>0042BD</b></p> <p>pencil point, 0.1 mm <math>\phi</math></p>	<p><b>0042LD</b></p> <p>angled face, 1 mm</p>	<p><b>0012BD</b></p> <p>pencil point</p>
--	---	--

## ERSADUR long-life soldering tip series 032

- ERSA 30 S



<p><b>0032KD</b></p> <p>ERSADUR, chisel-shaped, 3.1 mm</p>	<p><b>0032BD</b></p> <p>ERSADUR, pencil point, 1.1 mm <math>\phi</math></p>	<p><b>0032JD</b></p> <p>ERSADUR, chisel-shaped, 3.1 mm, bent</p>
--	---	--

## ERSADUR long-life soldering tip series 052

- ERSA 50 S



<p><b>0052JD</b></p> <p>ERSADUR, chisel-shaped, 3.1 mm, bent</p>
--

## ERSADUR long-life soldering tip series 082

- ERSA 80 S



<p><b>0082JD</b></p> <p>ERSADUR, chisel-shaped, 4.8 mm, bent</p>	<p><b>0082KD</b></p> <p>ERSADUR, chisel-shaped, 4.8 mm</p>
--	--

## ERSADUR long-life soldering tip series 152

- ERSA 150 S



<p><b>0152JD</b></p> <p>ERSADUR, chisel-shaped, 5.3 mm, bent</p>	<p><b>0152KD</b></p> <p>ERSADUR, chisel-shaped, 5.3 mm</p>
--	--

## ERSADUR/nickel-plated soldering tip series 202, 302 and 552

- ERSA 200 (series 202)
- ERSA 300 (series 302)
- ERSA 550 (series 552)



<p><b>0202MZ/0202MD</b></p> <p>MZ: nickel-plated, MD: ERSADUR chisel-shaped, reinforced, 18 mm</p>	<p><b>0302MZ/0302MD</b></p> <p>MZ: nickel-plated, MD: ERSADUR chisel-shaped, reinforced, 25 mm</p>	<p><b>0552MZ/0552MD</b></p> <p>MZ: nickel-plated, MD: ERSADUR chisel-shaped, reinforced, 35 mm</p>
--	--	--

## ERSADUR/nickel-plated desoldering tip series 722



- DIGITAL 2000 A with X-TOOL desoldering iron
- XT00LKIT1
- all i-CON stations with X-TOOL desoldering iron

<p><b>0722ED0821</b></p> <p>ERSADUR, ID 0.8 mm, OD 2.1 mm</p>	<p><b>0722ED1023</b> ERSADUR, ID 1.0 mm, OD 2.3 mm</p> <p><b>0722ED1226</b> ERSADUR, ID 1.2 mm, OD 2.6 mm</p>	<p><b>0722ED1529</b> ERSADUR, ID 1.5 mm, OD 2.9 mm</p> <p><b>0722ED2438</b> ERSADUR, ID 2.4 mm, OD 3.8 mm</p>
<p><b>0722EN0615S</b> nickel-plated, ID 0.6 mm, OD 1.5 mm</p> <p><b>0722EN1018S</b> nickel-plated, ID 1.0 mm, OD 1.8 mm</p>	<p><b>0722EN1023</b> nickel-plated, ID 1.0 mm, OD 2.3 mm</p> <p><b>0722EN0823</b> nickel-plated, ID 0.8 mm, OD 2.3 mm</p>	<p><b>0722EN1020</b> nickel-plated, ID 1.0 mm, OD 2.0 mm</p> <p><b>0722EN1023</b> nickel-plated, ID 1.0 mm, OD 2.3 mm</p>
<p><b>0722EN1223</b></p> <p>nickel-plated, ID 1.2 mm, OD 2.3 mm</p>	<p><b>0722EN1529</b> nickel-plated, ID 1.5 mm, OD 2.9 mm</p> <p><b>0722EN1548</b> nickel-plated, ID 1.5 mm, OD 4.8 mm</p>	<p><b>0722EN2332</b> nickel-plated, ID 2.3 mm, OD 3.2 mm</p> <p><b>0722EN2348</b> nickel-plated, ID 2.3 mm, OD 4.8 mm</p>

## ERSADUR/nickel-plated desoldering tip series 742



- i-CON VARIO stations with x-TOOL VARIO desoldering iron
- I-CON2 V with x-TOOL VARIO desoldering iron

<p><b>0742ED0616</b> ø ID 0.6 mm, ø OD 1.6 mm</p> <p>0742ED0616H</p>	<p><b>742ED0819</b> ø ID 0.8 mm, ø OD 1.9 mm</p> <p>0742ED0819H</p>	<p><b>742ED1023</b> ø ID 1.0 mm, ø OD 2.3 mm</p> <p>742ED1023H</p>
<p><b>0742ED1225</b> ø ID 1.2 mm, ø OD 2.5 mm</p> <p>0742ED1225H</p>	<p><b>742ED1529</b> ø ID 1.5 mm, ø OD 2.9 mm</p> <p>0742ED1529H</p>	<p><b>742ED2032</b> ø ID 2 mm, ø OD 3.2 mm</p> <p>0742ED2032H</p>
<p><b>0742ED2438</b> ø ID 2.4 mm, ø OD 3.8 mm</p> <p>0742ED2438H</p>	<p><b>0742ED2351H</b> for removal of residual SMT solder</p>	<p><b>0742ED1548H</b> for removal of residual SMT solder</p>

**Standard versions:** tinning on face only **H versions:** tinning of 2.5 mm length

Dimensions without pre-tinning

## Ersa inspection systems

For nearly fifteen years now, thousands of users worldwide have been benefiting from the ability to inspect hidden solder joints with the patented and award-winning ERSASCOPE inspection technology.

Industry experts, including the IPC, approve the great importance of using ERSASCOPE technology for the inspection of hidden solder joints. In combination with X-ray inspection equipment, the ERSASCOPE systems provide the most complete view of potential problems in the production process. ERSASCOPE remains to be the undisputed industry standard for optically inspecting BGAs and other hidden solder joints!

Whether for inspection under Flip-Chips or for inspection where other microscopes cannot see, ERSASCOPE technology offers a significant added value to any quality assurance program.

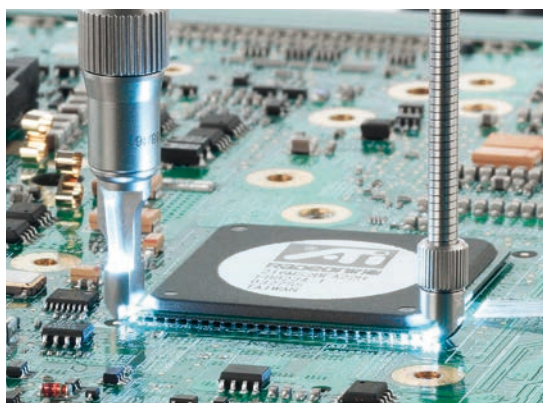

### ERSASCOPE 1 – the original

90° viewing capability with high magnification for the inspection of all common types of components

## ERSASCOPE series

**“Best in class” optical inspection technology for inspection of hidden solder joints.**

The award-winning and patented original ERSASCOPE technology has been further developed in order to meet today's challenges of lead-free soldering and low-profile components.

The ERSASCOPE 1 is a cost-effective and economic system for the optical inspection of BGAs and hidden interior solder joints of SMT and THT components in accordance with the new IPC Inspection Standards (see IPC-7095B)

The ERSASCOPE 2 is currently the **only** inspection system worldwide offering exchangeable optical heads for Flip-Chip, CSP, BGA and 0201 optical inspection.



### ERSASCOPE 2

Designed to handle low-profile components such as Flip-Chips,  $\mu$ BGAs and CSPs

## Ersa MOBILE SCOPE

The Ersa MOBILE SCOPE is a compact and handy, portable video microscope to inspect solder joints in electronic production environments. It has been designed for optical inspection and digital image recording including measurements of solder joints on Ball Grid Array (BGA),  $\mu$ BGA, CSP and Flip-Chip packages.

The Ersa MOBILE SCOPE is also suitable to inspect PCB lands and solder paste prints or for the optical inspection of components on printed circuit boards in Surface Mount Technology (SMT) or in Trough Hole Technology (THT) in general. Its application fields are in quality control, production, laboratories or R&D departments.



### MOBILE SCOPE

Mobile optical inspection system



## Ersa IR rework systems

Over the past two decades, rework and repair of electronic assemblies has been one of the most exciting and challenging undertakings in the industry. The PCBs' increasing complexity as well as the advancements in packages has put additional demands on both rework specialists and their equipment. Applications-oriented, innovative solutions are the key to success in this demanding field.

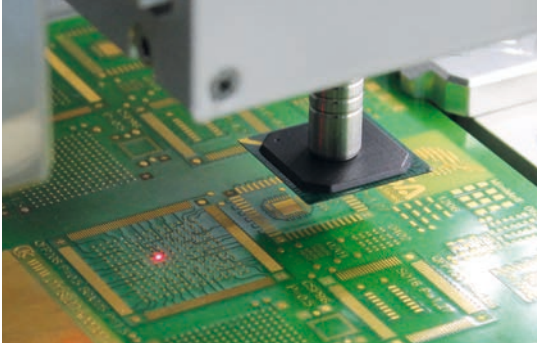

Ersa took on the rework challenge almost twenty years ago when it introduced its first patented medium wavelength infrared rework system, the Ersa IR 500. Today, we are proud to boast one of the world's largest installed equipment bases of several thousand systems ranging from smaller benchtop units to larger semi-automated machines. Ersa rework systems have proven themselves to be the undisputed leaders in handling the largest variety of rework applications. From the smallest 0201 up to large SMT connectors, from SMT Flip-Chips to THT Pin Grid Arrays, from BGA on flex circuit to stacked BGAs and from metal shields to plastic processor sockets, the safe IR technology handles it all.

The market leader's complete range of rework products is introduced and described in the Ersa "Rework and Inspection Catalog".

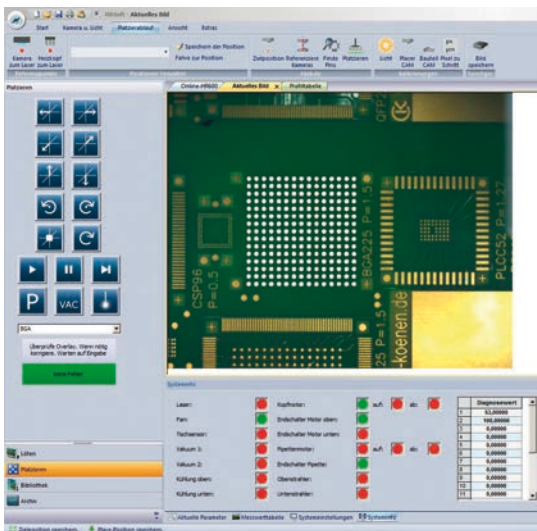

Ersa HRSOFT – comfortable software for process control and documentation



Ersa rework systems

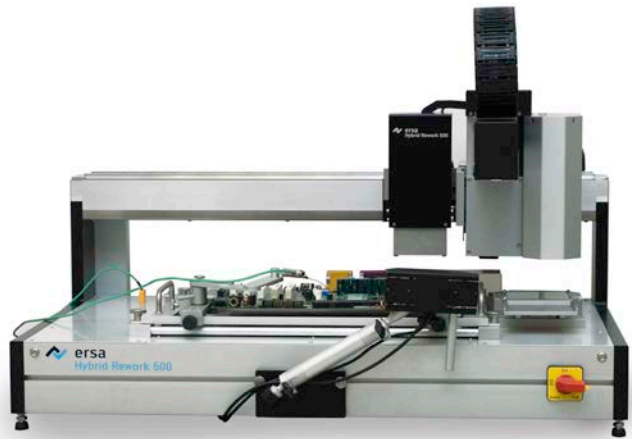

### HR 600/2 hybrid rework system

Redefined repair of assemblies – flexible, efficient, automated, safe! The new flagship of Ersa's rework product line with innovative technology



### HR 550 hybrid rework system

High-performance rework for specialists - the new Ersa rework platform

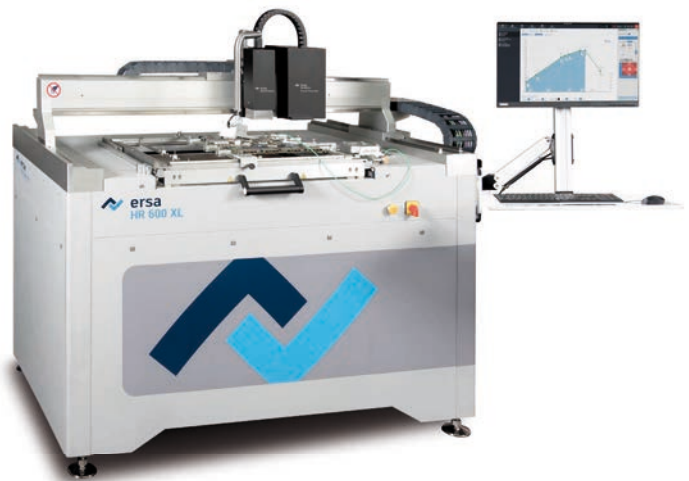

### HR 600 XL hybrid rework system

Developed for large board sizes of up to 625 x 625 mm. Safe handling of components with a size of up to 60 x 60 mm. Innovative IR Matrix Heater™ and 16 kW heating power for assemblies with high thermal demands.



## Ersa staff training and services



In addition to its comprehensive product range Ersa offers a wide range of services such as staff qualification and training, equipment- and process audits, ramp-up support or equipment capability studies and consultations in special applications. Ersa provides its customers comprehensive possibilities to carry out application tests in the 400 m<sup>2</sup> Ersa Application and Demo Center.

Staff qualification is extremely important to Ersa. Take advantage of qualified employees yourself and participate in our training and qualification courses. Being a member of the soldering training union "Ausbildungsverband Löt Schulungen" Ersa offers, for example, trainings as Qualified Hand Soldering Specialist/Electronics Production according to uniform standards throughout the year and conducts Know How Seminars on machine and process technology. Please refer to our website or program flyers for further information and current dates.

## Training as qualified hand soldering specialist



### Your advantages

Well-educated and qualified employees save costs: process deviations can be identified and corrected before they lead to defects avoiding unnecessary rework. Further benefits are the optimal use of materials and reproducible quality. Since the participants are trained according to standardized and approved regulations they will all reach one level, finishing the several day training course with a certified technical and practical exam.

### Target group

Electronic production industry, mechanical engineering companies with their own electronic production, prototype and pattern makers. Employees from production departments, quality managers and engineers who are to produce or repair RoHS complying electronic products in the hand soldering process.

### Contents

The qualified hand soldering specialist will obtain a basic understanding for hand soldering electronic components – this means he/she will learn to understand the contents of working instructions and to professionally and independently create hand solder

joints according to instructions. Material properties will be discussed, and the necessity of a balance between soldering heat requirements and soldering heat resistance will be explained and tested afterwards by the trainees. The trainees will intensify the theoretical and practical knowledge they gained during the training course later in their daily work.

### Teaching methods and equipment

Each participant will obtain a hand soldering workplace with ESD equipment. Therefore the courses are limited to max. 10 persons. Furthermore, heating plates, soldering and desoldering stations, one inspection workplace as well as component preparation spots are available. The participants' progress in their capabilities is evaluated and documented during the training course. These practical results are the basis for the admission to the final exams for the qualified hand soldering expert.

## Ersa – Europe's largest manufacturer of **soldering systems**



Being Europe's largest manufacturer of soldering systems Ersa has the most comprehensive product range in the joining technology in electronics production.

In the field of soldering systems, solder paste printers, reflow ovens as well as wave- and selective soldering systems are offered. On account of the close cooperation with many leading manufacturers in global electronic production, our awareness of the stringent demands pertaining to this dynamic industry has been able to grow and to mature over the years.

Reliable processes, lowest defect rates and ever increasing productivity at an extremely economical consumption of resources and very low maintenance costs – these are challenges Ersa machines face every day.

Learn more in one of our soldering machine brochures or on our website.

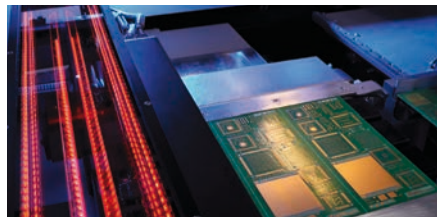

Screen printing



Reflow soldering

### Screen printers

The models of Ersa's VERSAPRINT 2 screen printers offer the user unique advantages with their fully integrated full-area AOI at line speed after the printing process.

### Reflow soldering

Ersa's reflow systems have been in the technological lead for many years already. The Ersa HOTFLOW series convinces with lowest TCO values attained through the systems' unsurpassed thermal performance, highest machine uptimes and lowest operating costs. A number of models differing in process tunnel length, process gas cleaning and conveyor system are available. Reflow programs are quickly and easily generated off-line with the very user-friendly system software and the Autoprofiler.



Wave soldering



Selective soldering

### Wave soldering

The cost-benefit ratio of wave soldering is still outstanding. Nevertheless, the demands of the users differ widely. Therefore, Ersa offers an extensive range of individually configurable systems, from basic to high-end.

### Selective soldering

Having sold and installed VERSAFLOW in-line selective soldering systems worldwide Ersa is both market and technology leader. The modular design of the VERSAFLOW series offers virtually unlimited combination possibilities in a "classical production line" whereas the ECOCELL is ideally suited for production islands. The ECOSELECT models are perfect start-up solutions which can be operated as stand-alone or in-line systems.

# Sustainability is an integral part of our corporate culture

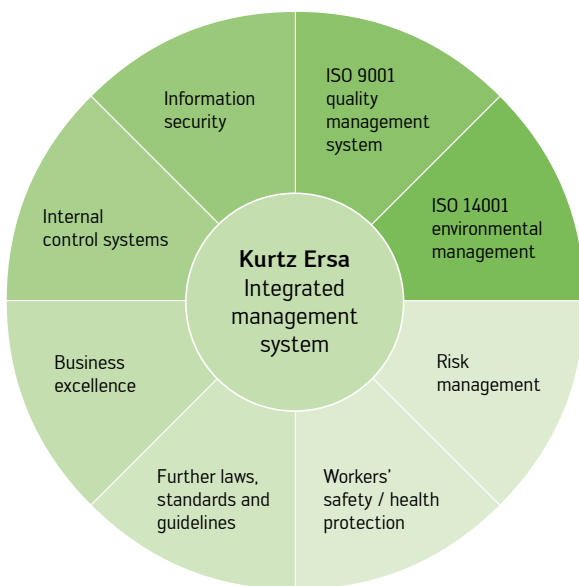

Rightfully, our customers expect that we take the extra step, and that is why we have an understanding of quality not permitting any compromises. Permanently monitoring our customers' expectations and matching these to our own strategic objectives defines our target. To achieve our target, we build on consequent quality management as our guiding principle, on comprehensive internal and external certifications as well as on competent, quality-conscious employees.

Our first production plant – a forge hammer mill, which started to produce in 1779 – was operated with water power. This historical industrial landmark is maintained as a visual symbol of a sustainable corporate development.

Sustainability is an integral part of Kurtz Ersa's corporate culture, in our product development and manufacturing processes. In this way we want to contribute our share to sustainably improve the living conditions on our planet earth.

The base for the processes' systematic control is our management system. For this reason, we have incorporated the sustainability aspect into this management system, thereby creating the basis so that all our employees are included as well in their daily actions.

The sustainability aspect in our own diverse manufacturing processes is closely monitored with improvements being mandated regularly. Internal and external audits ensure the success of this process.

In the development cycle of our own products, the improvement potential regarding the use of resources is defined already in the equipment specification.

At Kurtz Ersa, the concept of sustainability is taken seriously.

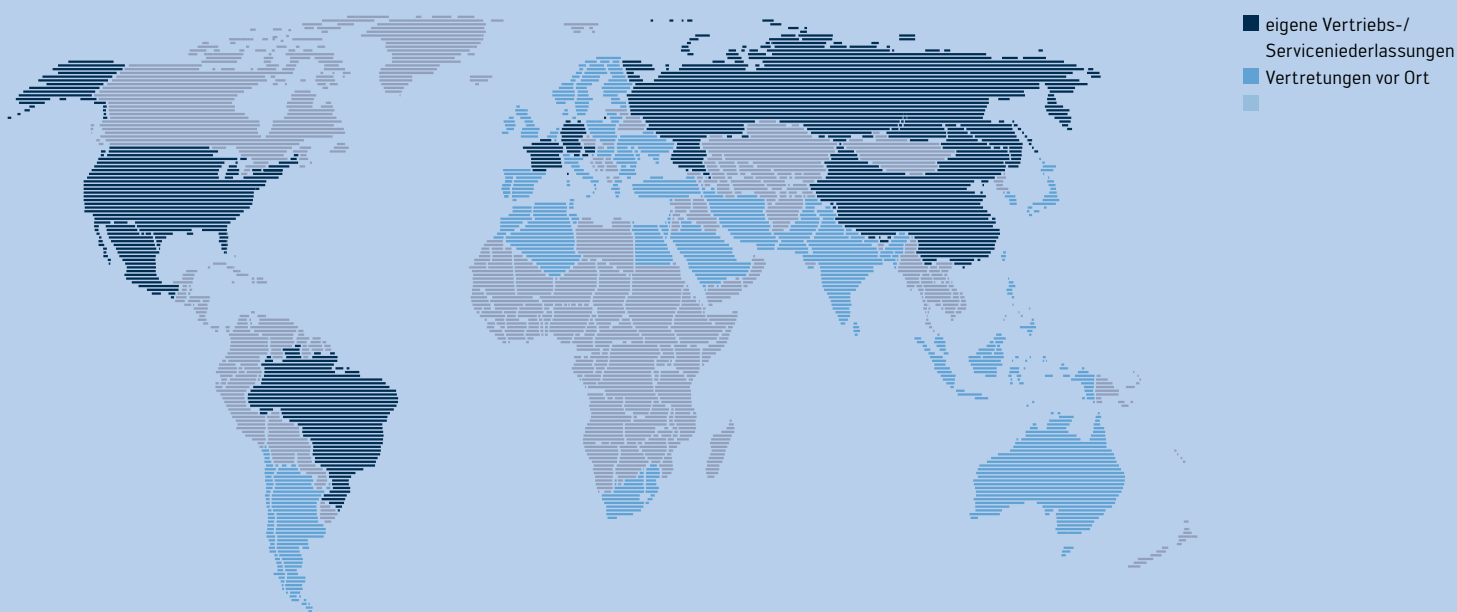

**Dystrybutor:**

Elblinger Elektronik Sp. z o.o.  
ul. Kwiatowa 25  
60-185 Skórzewo k. Poznań

Telefon: 061 / 894 69 90  
Fax: 061 / 894 69 99

E-mail: [mail@elblinger-elektronik.pl](mailto:mail@elblinger-elektronik.pl)  
Internet: [www.elblinger-elektronik.pl](http://www.elblinger-elektronik.pl)