

SEP8506

GaAs Infrared Emitting Diode

FEATURES

- Side-emitting plastic package
- 50° (nominal) beam angle
- 935 nm wavelength
- Mechanically and spectrally matched to SDP8406 phototransistor, SDP8106 photodarlington and SDP8000/8600 series Schmitt trigger

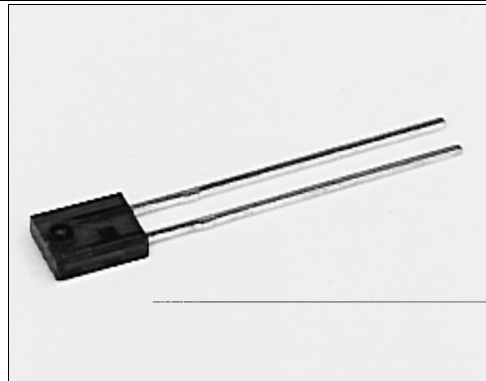

INFRA-20.TIF

DESCRIPTION

The SEP8506 is a gallium arsenide infrared emitting diode molded in a side-emitting red plastic package. The chip is positioned to emit radiation through a plastic lens from the side of the package.

OUTLINE DIMENSIONS in inches (mm)

Tolerance 3 plc decimals $\pm 0.005(0.12)$
2 plc decimals $\pm 0.020(0.51)$

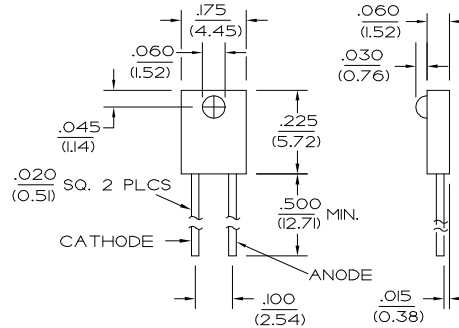

DIM_071.dwg

SEP8506

GaAs Infrared Emitting Diode

ELECTRICAL CHARACTERISTICS (25°C unless otherwise noted)

PARAMETER	SYMBOL	MIN	TYP	MAX	UNITS	TEST CONDITIONS
Irradiance ⁽¹⁾	H				mW/cm ²	I _F =20 mA
SEP8506-001		0.05		0.36		
SEP8506-002		0.33		0.52		
SEP8506-003		0.45		0.90		
Forward Voltage	V _F			1.5	V	I _F =20 mA
Reverse Breakdown Voltage	V _{BR}	3.0			V	I _R =10 μA
Peak Output Wavelength	λ _p		935		nm	
Spectral Bandwidth	Δλ		50		nm	
Spectral Shift With Temperature	Δλ _p /ΔT		0.3		nm/°C	
Beam Angle ⁽²⁾	Ø		50		degr.	I _F =Constant
Radiation Rise And Fall Time	t _r , t _f		0.7		μs	

Notes

1. Measured in mW/cm² into a 0.104 (2.64) diameter aperture placed 0.535 (13.6) from the lens tip.
2. Beam angle is defined as the total included angle between the half intensity points.

ABSOLUTE MAXIMUM RATINGS

(25°C Free-Air Temperature unless otherwise noted)

Continuous Forward Current	50 mA
Power Dissipation	100 mW ⁽¹⁾
Storage Temperature Range	-40°C to 85°C
Operating Temperature Range	-40°C to 85°C
Soldering Temperature (5 sec)	240°C

Notes

1. Derate linearly from 25°C free-air temperature at the rate of 0.78 mW/°C.

SCHEMATIC



Honeywell reserves the right to make changes in order to improve design and supply the best products possible.

Honeywell

SEP8506

GaAs Infrared Emitting Diode

Fig. 1 Radiant Intensity vs Angular Displacement gra_030.ds4

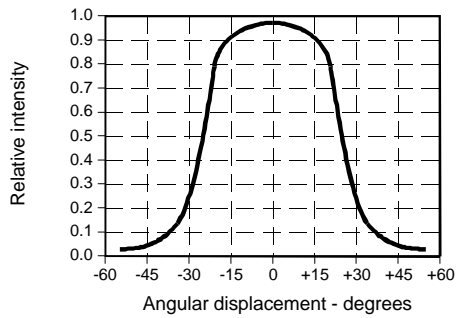

Fig. 2 Radiant Intensity vs Forward Current gra_028.ds4

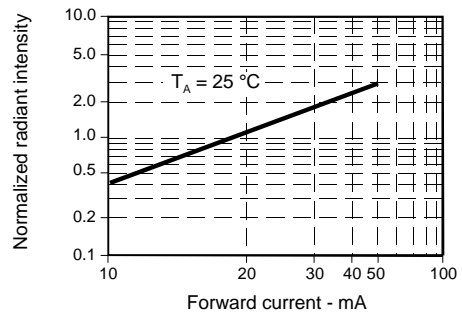

Fig. 3 Forward Voltage vs Forward Current gra_003.ds4

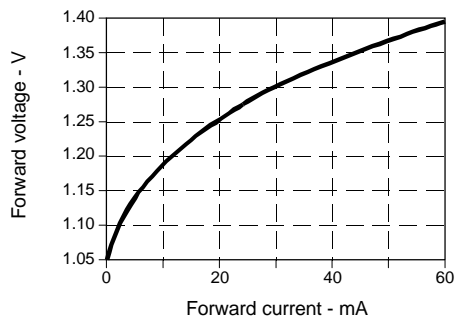

Fig. 4 Forward Voltage vs Temperature gra_207.ds4

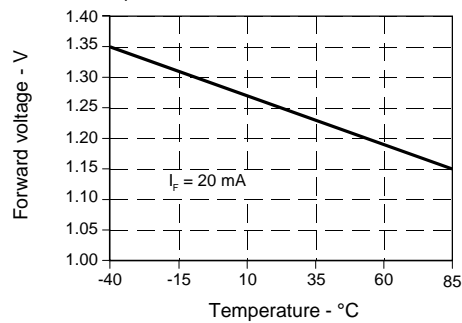

Fig. 5 Spectral Bandwidth gra_005.ds4

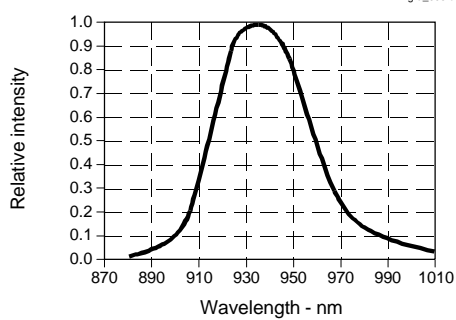
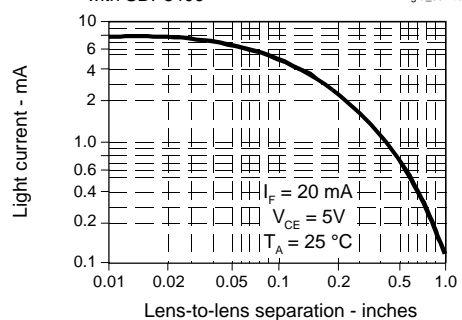
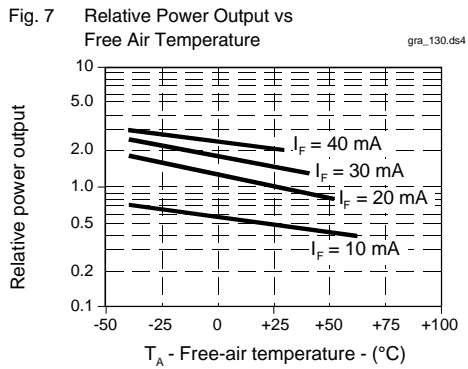

Fig. 6 Coupling Characteristics with SDP8406 gra_031.ds4



SEP8506

GaAs Infrared Emitting Diode



All Performance Curves Show Typical Values

Honeywell reserves the right to make changes in order to improve design and supply the best products possible.

Honeywell

43



Elblinger Elektronik GmbH
Lange Wanne 25
38259 Salzgitter

Telefon 05341/8212-1
Fax 05341/821299

e-mail mail@elblinger-elektronik.de
Internet www.elblinger-elektronik.de