

SD1420

Silicon Photodiode

FEATURES

- Compact, metal can coaxial package
- 24° (nominal) acceptance angle
- Wide operating temperature range (-55°C to +125°C)
- Mechanically and spectrally matched to SE1450 and SE1470 infrared emitting diodes

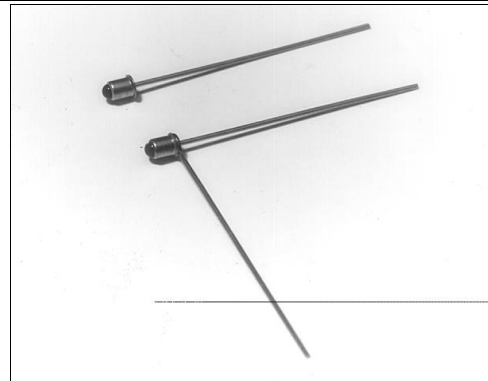

INFRA-63.TIF

DESCRIPTION

The SD1420 is a PN junction silicon photodiode mounted in a glass lensed metal can coaxial package. The package may have a tab or second lead welded to the can as an optional feature (SD1420-XXXL). Both leads are flexible and may be formed as required to fit various mounting configurations.

OUTLINE DIMENSIONS in inches (mm)

Tolerance 3 plc decimals ±0.005(0.12)
2 plc decimals ±0.020(0.51)

SD1420-XXX

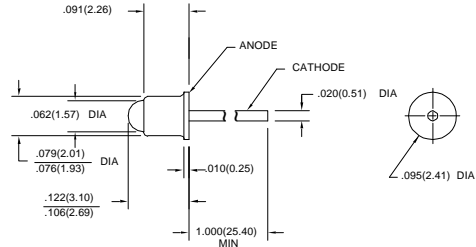

DIM_10a.ds4

SD1420-XXXL

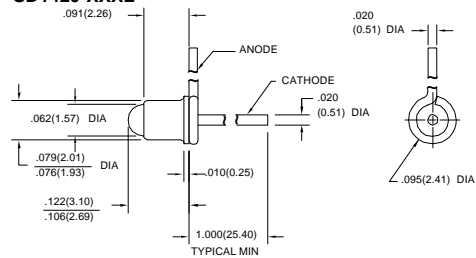

DIM_10b.ds4

SD1420

Silicon Photodiode

ELECTRICAL CHARACTERISTICS (25°C unless otherwise noted)

PARAMETER	SYMBOL	MIN	TYP	MAX	UNITS	TEST CONDITIONS
Light Current SD1420-002, SD1420-002L	I_L	5.0			μA	$V_R=20\text{ V}$ $H=5\text{ mW/cm}^2$ (1)
Dark Current	I_D			5.0	nA	$V_R=20\text{ V}$ $H=0$
Reverse Breakdown Voltage	V_{BR}	50			V	$I_R=10\ \mu\text{A}$
Angular Response (2)	\emptyset		24		degr.	$I_F=\text{Constant}$
Rise And Fall Time	t_r, t_f		50		ns	$V_R=20\text{ V}$ $R_L=50\ \Omega$

Notes

- The radiation source is a tungsten lamp operating at a color temperature of 2870°K.
- Angular response is defined as the total included angle between the half sensitivity points.

ABSOLUTE MAXIMUM RATINGS

(25°C Free-Air Temperature unless otherwise noted)

Cathode Anode Voltage	50 V
Power Dissipation	75 mW (1)
Operating Temperature Range	-55°C to 125°C
Storage Temperature Range	-65°C to 150°C
Soldering Temperature (10 sec)	260°C

Notes

- Derate linearly from 25°C free-air temperature at the rate of 0.71 mW/°C.

SCHEMATIC

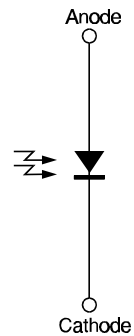

Honeywell reserves the right to make changes in order to improve design and supply the best products possible.

Honeywell

SD1420

Silicon Photodiode

SWITCHING TIME TEST CIRCUIT

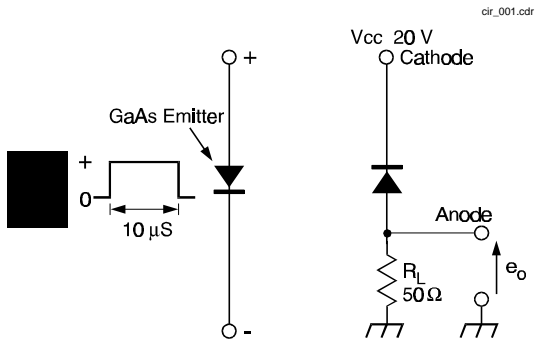

Fig. 1 Responsivity vs Angular Displacement

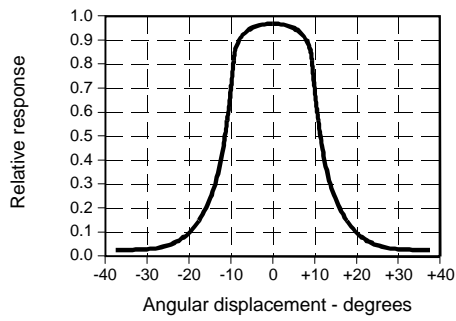
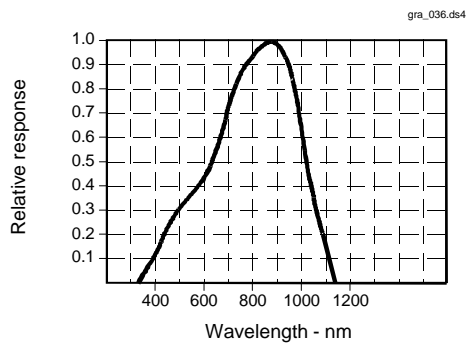

Fig. 3 Spectral Responsivity



All Performance Curves Show Typical Values

SWITCHING WAVEFORM

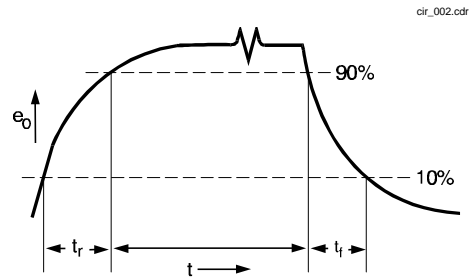
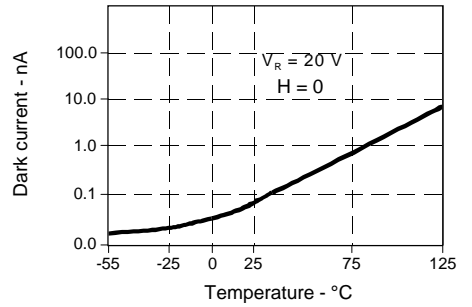

Fig. 2 Dark Current vs Temperature



SD1420
Silicon Photodiode



Honeywell reserves the right to make changes in order to improve design and supply the best products possible.

Honeywell

83



Elblinger Elektronik GmbH
Lange Wanne 25
38259 Salzgitter

Telefon 05341/8212-1
Fax 05341/821299

e-mail mail@elblinger-elektronik.de
Internet www.elblinger-elektronik.de