

HOA1404

Reflective Sensor

FEATURES

- Choice of phototransistor or photodarlington output
- Focused for maximum response
- Wide operating temperature range (-55°C to +100°C)

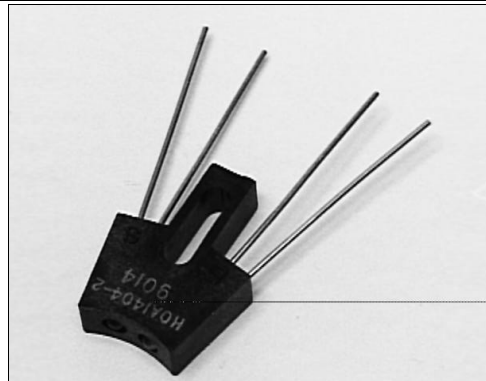

INFRA-61.TIF

DESCRIPTION

The HOA1404 series consists of an infrared emitting diode and an NPN silicon phototransistor (HOA1404-001,-002) or photodarlington (HOA1404-003), encased side-by-side on converging optical axes, in a black thermoplastic housing. The detector responds to radiation from the IRED only when a reflective object passes within its field of view. The HOA1404 series employs metal can packaged components. For additional component information see SE1450, SD1440, and SD1410.

Housing material is acetal copolymer. Housings are soluble in chlorinated hydrocarbons and ketones. Recommended cleaning agents are methanol and isopropanol.

OUTLINE DIMENSIONS in inches (mm)

Tolerance 3 plc decimals ±0.010(0.25)
2 plc decimals ±0.020(0.51)

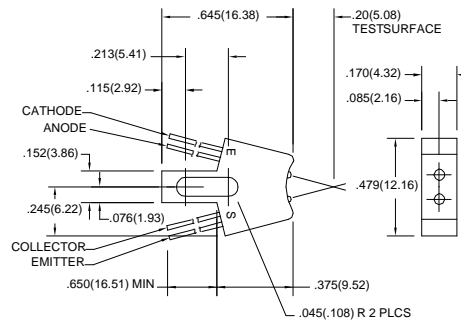

DIM_037.d54

HOA1404

Reflective Sensor

ELECTRICAL CHARACTERISTICS (25°C unless otherwise noted)

PARAMETER	SYMBOL	MIN	TYP	MAX	UNITS	TEST CONDITIONS
IR EMITTER						
Forward Voltage	V_F			1.6	V	$I_F=20\text{ mA}$
Reverse Leakage Current	I_R			10	μA	$V_R=3\text{ V}$
DETECTOR						
Collector-Emitter Breakdown Voltage HOA1404-001, -002 HOA1404-003	$V_{(BR)CEO}$	30 15			V	$I_C=100\ \mu\text{A}$
Emitter-Collector Breakdown Voltage	$V_{(BR)ECO}$	5.0			V	$I_E=100\ \mu\text{A}$
Collector Dark Current HOA1404-001, -002 HOA1404-003	I_{CEO}			100 250	nA	$V_{CE}=10\text{ V}$ $I_F=0$
COUPLED CHARACTERISTICS						
On-State Collector Current HOA1404-001 HOA1404-002 HOA1404-003	$I_{C(ON)}$	0.2 0.8 2.0			mA	$V_{CE}=5\text{ V}$ $I_F=30\text{ mA}$ (1)
Collector-Emitter Saturation Voltage HOA1404-001 HOA1404-002 HOA1404-003	$V_{CE(SAT)}$			0.4 0.4 1.1	V	$I_F=30\text{ mA}$ (1) $I_C=30\ \mu\text{A}$ $I_C=100\ \mu\text{A}$ $I_C=250\ \mu\text{A}$
Rise And Fall Time HOA1404-001, -002 HOA1404-003	t_r, t_f			15 75	μs	$V_{CC}=5\text{ V}, I_C=1\text{ mA}$ $R_L=1000\ \Omega$ $R_L=100\ \Omega$

Notes

1. Test surface is a front surface mirror (polished aluminum, 85% reflectance) located 0.20 in.(5.0 mm) from the front surface of the device.

ABSOLUTE MAXIMUM RATINGS

(25°C Free-Air Temperature unless otherwise noted)

Operating Temperature Range -55°C to 100°C

Storage Temperature Range -55°C to 125°C

Soldering Temperature (10 sec) 260°C

IR EMITTER

Power Dissipation 75 mW (1)

Reverse Voltage 3 V

Continuous Forward Current 50 mA

DETECTOR

Collector-Emitter Voltage 30 V TRANS. 15 V DARLINGTON

Emitter-Collector Voltage 5 V 5 V

Power Dissipation 75 mW (1) 75 mW (1)

Collector DC Current 30 mA 30 mA

SCHEMATIC

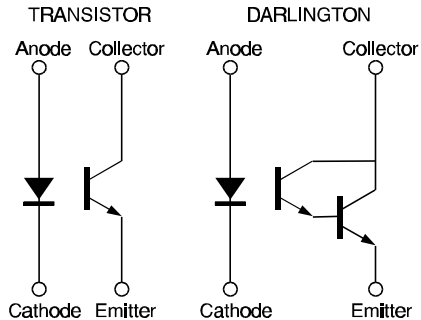

Honeywell reserves the right to make changes in order to improve design and supply the best products possible.

Honeywell

HOA1404

Reflective Sensor

Fig. 1 IRED Forward Bias Characteristics

gra_073.ds4

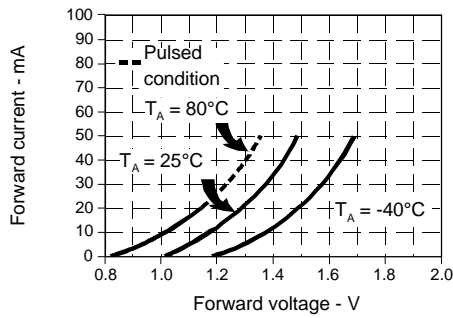

Fig. 2 Non-Saturated Switching Time vs Load Resistance

gra_079.ds4

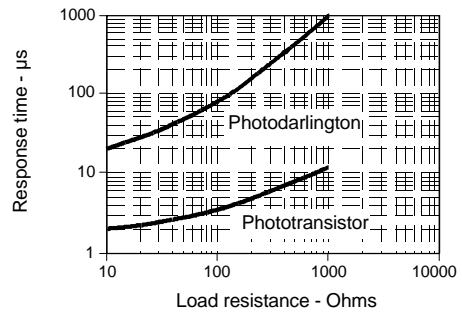

Fig. 3 Dark Current vs Temperature

gra_303.cdr

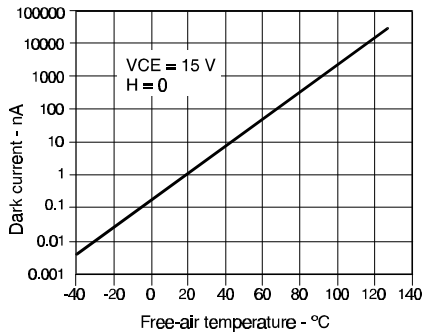

Fig. 4 Collector Current vs Ambient Temperature

gra_076.ds4

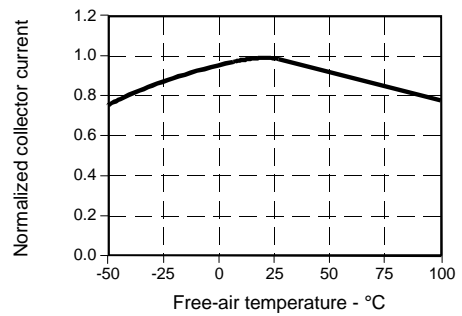

Fig. 5 Collector Current vs Distance to Reflective Surface

gra_088.ds4

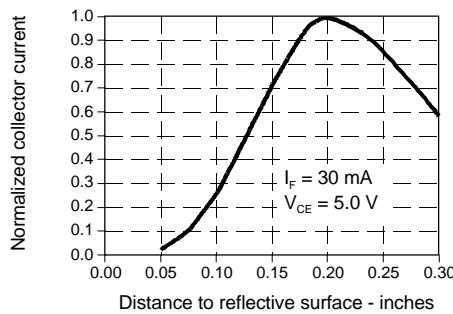
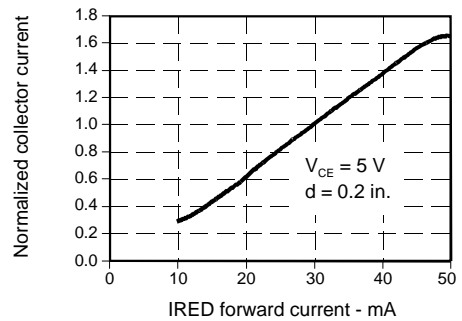

Fig. 6 Collector Current vs IRED Forward Current

gra_089.ds4



All Performance Curves Show Typical Values

HOA1404
Reflective Sensor



Honeywell reserves the right to make changes in order to improve design and supply the best products possible.

Honeywell