

BR-1225A

DIMENSIONS (MM)

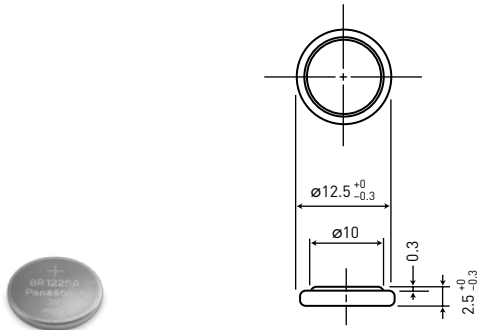

Model number	BR-1225A
Nominal voltage (V)	3
Nominal capacity (mAh)	48
Diameter (mm)	12.5
Total height (mm)	2.5
Discharging temperature range (°C)	-40 to +125
Weight (g)	0.8

DISCHARGE TEMPERATURE CHARACTERISTICS

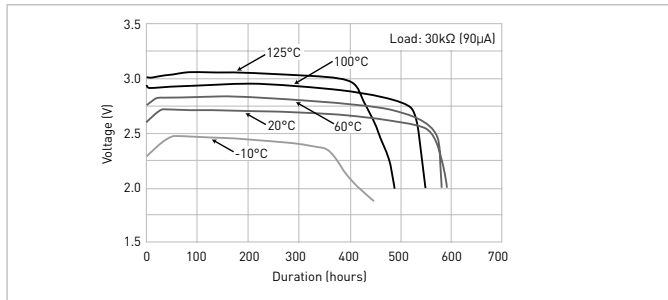

BR-1632A

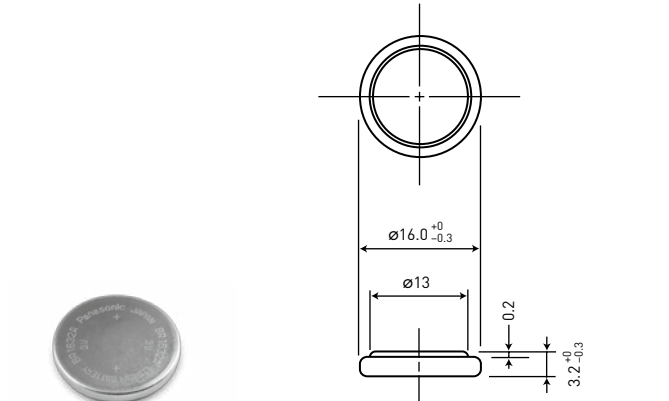

Model number	BR-1632A
Nominal voltage (V)	3
Nominal capacity (mAh)	120
Diameter (mm)	16.0
Total height (mm)	3.2
Discharging temperature range (°C)	-40 to +125
Weight (g)	1.5

DISCHARGE TEMPERATURE CHARACTERISTICS

